



Description

EN Round or square, slim rectangular lamp made of aluminium; $\pm 10^\circ$ rotatable; surface black or natural anodised; plug and play electrical connector system for toolless mounting; beam angle 132° ; passively cooled high-power LED system; available in the light colours 3000K and 4000K; min. 90% of the luminous flux after 50000 hours; colour rendering $CRI \geq 95$ ($R9 \geq 90$); 350mA converter plug and play; converter separately available; degree of protection IP20; PC I / PC II (power supply) or PC III (light insets); optionally non-dimmable or DALI-2 control

FR Luminaire rectangulaire fin et rond ou carré en aluminium ; rotatif à $\pm 10^\circ$; surface noire ou anodisée naturel ; système de branchement électrique par trous métallisés pour montage sans outil ; angle de diffusion 132° ; système à LED haute puissance à refroidissement passif ; livrable dans les couleurs de lumière 3000K et 4000K ; min. 90% du flux lumineux au bout de 50000h de durée de vie ; rendu de couleur $CRI \geq 95$ ($R9 \geq 90$) ; convertisseur de 350mA préassemblé prêt à brancher ; convertisseur à commander séparément ; genre protection IP20 ; CP I / CP II (alimentation électrique) ou CP III (éléments lumineux) ; en option non gradable ou commande via DALI-2

PICO SUPPORT round/square standing

Quickinfo

3000 K, 4000 K
 $CRI \geq 95$ ($R9 \geq 90$)
 L90 @ 50000h
 L 290 up to 249lm
 L 580 up to 498lm
 L 880 up to 747lm
 L 1180 up to 996lm
 non DIM, DALI-2

Types

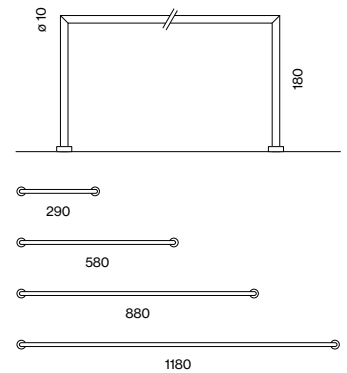

Colours



Light distribution



Order options

COLOUR TEMPERATURE			☼☼
3000K	CRI≥95	70lm*	5
4000K	CRI≥95	83lm*	6

*per LED | CRI≥95 (R9≥90) | 350mA | 53°C

MATERIAL COLOUR			☑
anodised aluminium			6
anodised black			8



PICO SUPPORT round standing

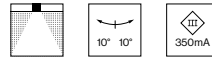

SYSTEM POWER / VOLTAGE	NO. OF LEDS	L (mm)	ORDER CODE
3×1.1W / 10V	3	290	007-4201::1☑
6×1.1W / 19V	6	580	007-4202::1☑
9×1.1W / 29V	9	880	007-4203::1☑
12×1.1W / 38V	12	1180	007-4204::1☑

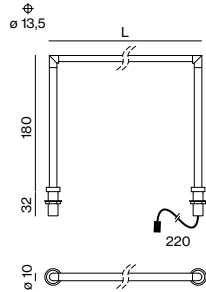

PICO SUPPORT square standing

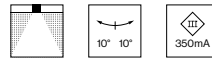

SYSTEM POWER / VOLTAGE	NO. OF LEDS	L (mm)	ORDER CODE
3×1.1W / 10V	3	290	007-4211::1☑
6×1.1W / 19V	6	580	007-4212::1☑
9×1.1W / 29V	9	880	007-4213::1☑
12×1.1W / 38V	12	1180	007-4214::1☑

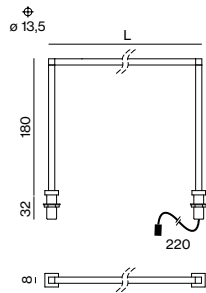

ILLUMINANCE EXAMPLE (E_{max} in lux)

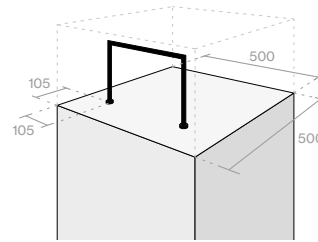

BEAM ANGLE	COLOUR TEMP.	L 290mm 1x(3x1.1W)
132°	3000K	1626

reflection factors 0.2/0.5/0.7
maintenance factor 0.8

LIGHT DISTRIBUTION

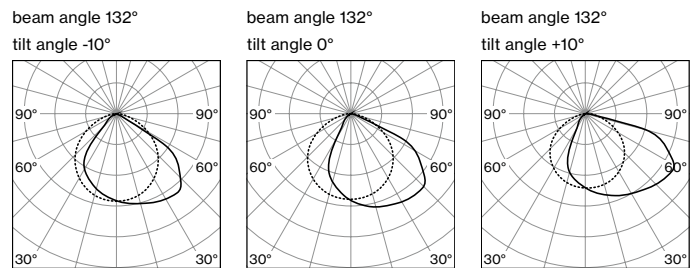

Electrical accessories

CONVERTER supply 220-240V AC, 350 mA, 50-60 Hz

incl. power cable 2m + connection cable with plug 1m

TYPE	FIXTURES	CABLE (m)	L-W-H (mm)	ORDER CODE
7W / 3-14V non DIM	☐ PC II 1-2	max. 12	68-35-21	007-1951160
30W / 2-50V non DIM	⊕ PC I 1-5	max. 18	187-30-21	007-1951560
18W / 10-54V DALI-2	☐ PC II 2-5	max. 18	147-44-30	007-1951580

SPLITTER SERIAL, AWG22

TYPE	INPUT / OUTPUT	L-W-H (mm)	ORDER CODE
splitter 350mA + cable 500mm	1×socket / 9×plug	85-50-10	007-1959110

EXTENSION CABLE

TYPE	INPUT / OUTPUT	L (mm)	ORDER CODE
extension cable	1×socket / 1×plug	1000	007-1961260
extension cable	1×socket / 1×plug	2000	007-1961460
extension cable	1×socket / 1×plug	4000	007-1961660