

XAL 23

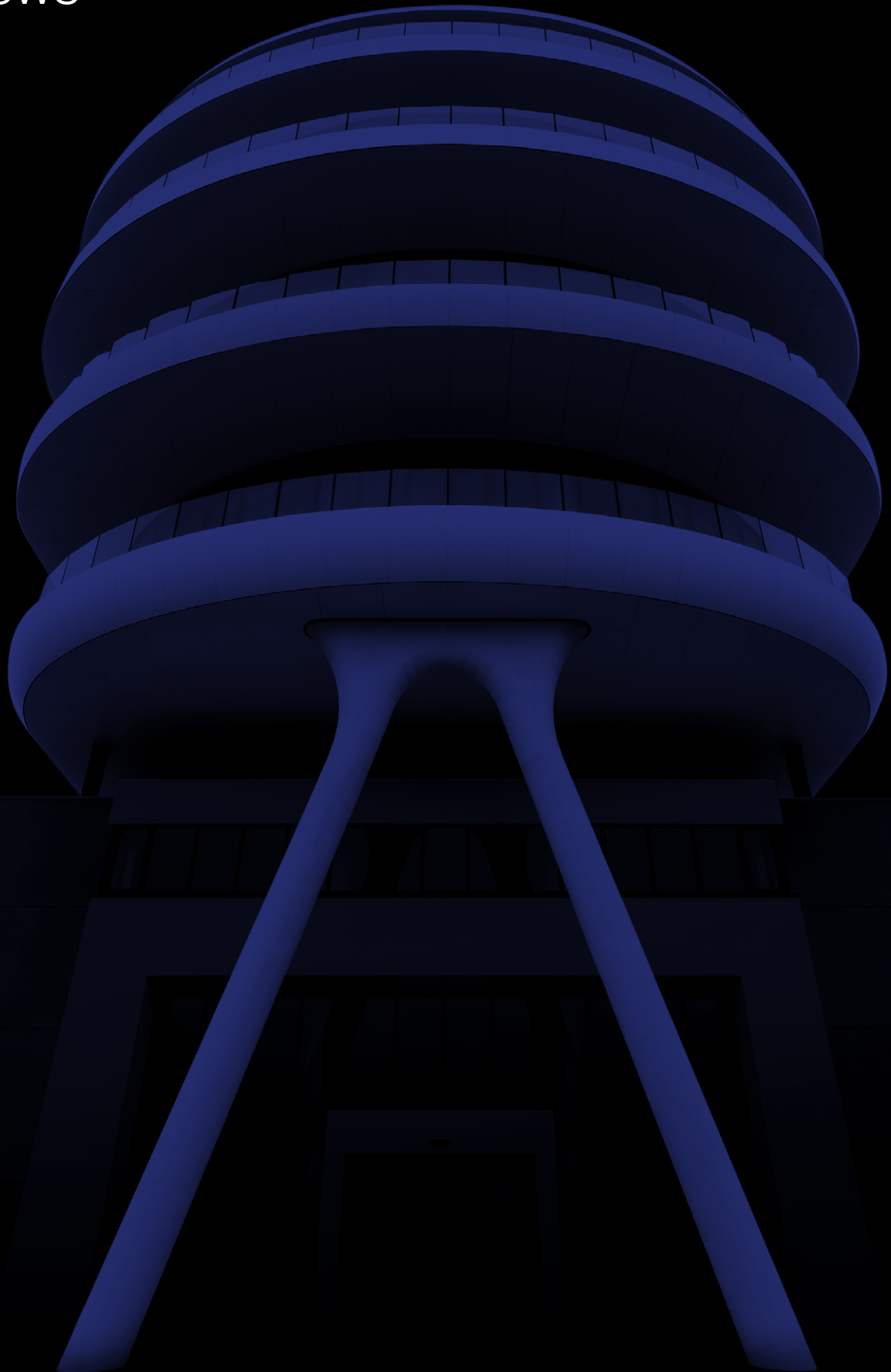



EN IT

News



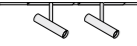
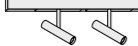



Contents

MOVE IT 10
installation track

				
recessed trimless	surface square	suspended square	suspended round	pole square/round
12	12	14	14	16



linear insets

			
SPOT LINE direct	OPAL direct	DARKLIGHT direct	indirect
20	20	20	20

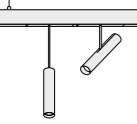
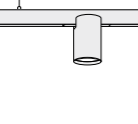
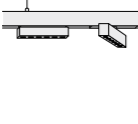
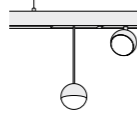
decorative insets

			
TILA	TARO	GIRA	NOBA
24	32	36	40

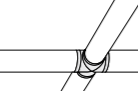
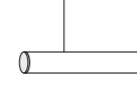
TUBO 60
surface

		suspended		
system	CONEX system		system	CONEX system
48	48		48	48



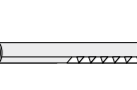
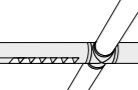
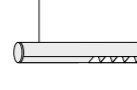
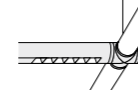

SETA
ceiling

		suspended		
system	CONEX system		system	CONEX system
48	48		48	48



MITA
ceiling

	suspended	
circle		suspended
58		64



SPIO
recessed

			
20 downlight	20 wallwasher	60 downlight	60 adjustable
72	72	76	76

SQUADRO
recessed

	track	
wallwasher		wallwasher
84		88

BO
intrack

		
32 2/3 lamps	45 2/3 lamps	55 1/2 lamps
96	96	96

VARO
track

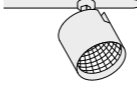
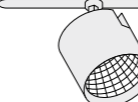
	
80 S	110 S
104	108



MILA
ceiling

system
116

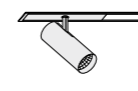
FRAME 40
recessed trim

	
system	system
124	130

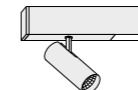
MINO 40
ceiling

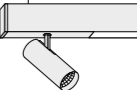
		suspended		
system	system		40 system	40 system
128	130		128	130





















Elegance on track



MOVE IT 10 system

EN MOVE IT 10 is a particularly slim track system. The dimmable low-voltage track, available as a recessed, surface-mounted, suspended or pole version, is impressive thanks to its unusually slender cross-section. Both the round and square forms have a clear width of only 10 mm. MOVE IT 10's design is minimalistic. The insets' adapter are fully hidden in the track. The tracks are available in black, white and chrome (standard for the round version). They are connected by Corner or Curve elements for an edgy or softly rounded appearance. Extend MOVE IT 10 with various linear or design-oriented insets for maximum planning freedom for your interior concept.

IT Un binario elettrificato ultrasottile: è questo MOVE IT 10. Si tratta di un binario dimmerabile a bassa tensione, previsto in variante da incasso, a plafone, a sospensione o su palo. Convince soprattutto per la sua sezione davvero minima: sia in forma rotonda che angolare, la larghezza netta misura solo 10 mm. Il design minimalista è ripreso anche negli adattatori, che scompaiono completamente nei binari. I colori disponibili sono il nero, bianco e cromo (per la versione rotonda). I binari si collegano con elementi Corner o Curve in modo da formare angoli squadrati o curve morbide. MOVE IT 10 si può ampliare con vari inserti lineari o di design, per la massima libertà di progettazione degli interni.

Types							
	square	round					
Mountings							
	recessed	surface	suspended	pole			
Configurations							
	linear	curve	L-connector	T-connector	X-connector	level connector	ceiling to wall connector
Light distributions							
	spot line	opal	darklight	spotlight	decorative	wallwasher floor	direct indirect

Mounting options

EN Depending on the desired appearance and installation, the 48V track system is available as a trimless recessed-mounted, surface-mounted, suspended or pole version.

IT A seconda dell'aspetto e del tipo di montaggio preferito, il sistema di binari a 48V è disponibile in variante da incasso, a plafone, sospensione o palo.



Create individual arrangements

EN Let your creativity run wild and arrange MOVE IT 10 at will. Special Curve and Corner elements enable the straight tracks to be connected to form harmonious curves or precise corners. Since all elements fit together, you can configure your ideal bespoke system.

IT Date libero sfogo alla creatività componendo MOVE IT 10 secondo le vostre idee. Gli elementi speciali Curve e Corner consentono di unire i binari formando curve armoniose o angoli precisi. Dato che tutti gli elementi sono compatibili, si può configurare il sistema individualmente in base alle preferenze e allo spazio disponibile.

Track shapes

EN In both the round and square form, the track opens options for flexible application. Their track diameter is only 29 mm, presenting a reduced and sleek appearance. Many insets offer an optional flush adapter to create an even, visually calm ceiling appearance.

IT Di forma rotonda o angolare, il binario offre possibilità applicative flessibili. Il diametro misura fino a 29 mm e assicura quindi un'ottica ridotta ed elegante. Molti inserti sono costruiti con un adattatore a filo, in modo che il soffitto mantenga un aspetto d'insieme unitario e riposante.

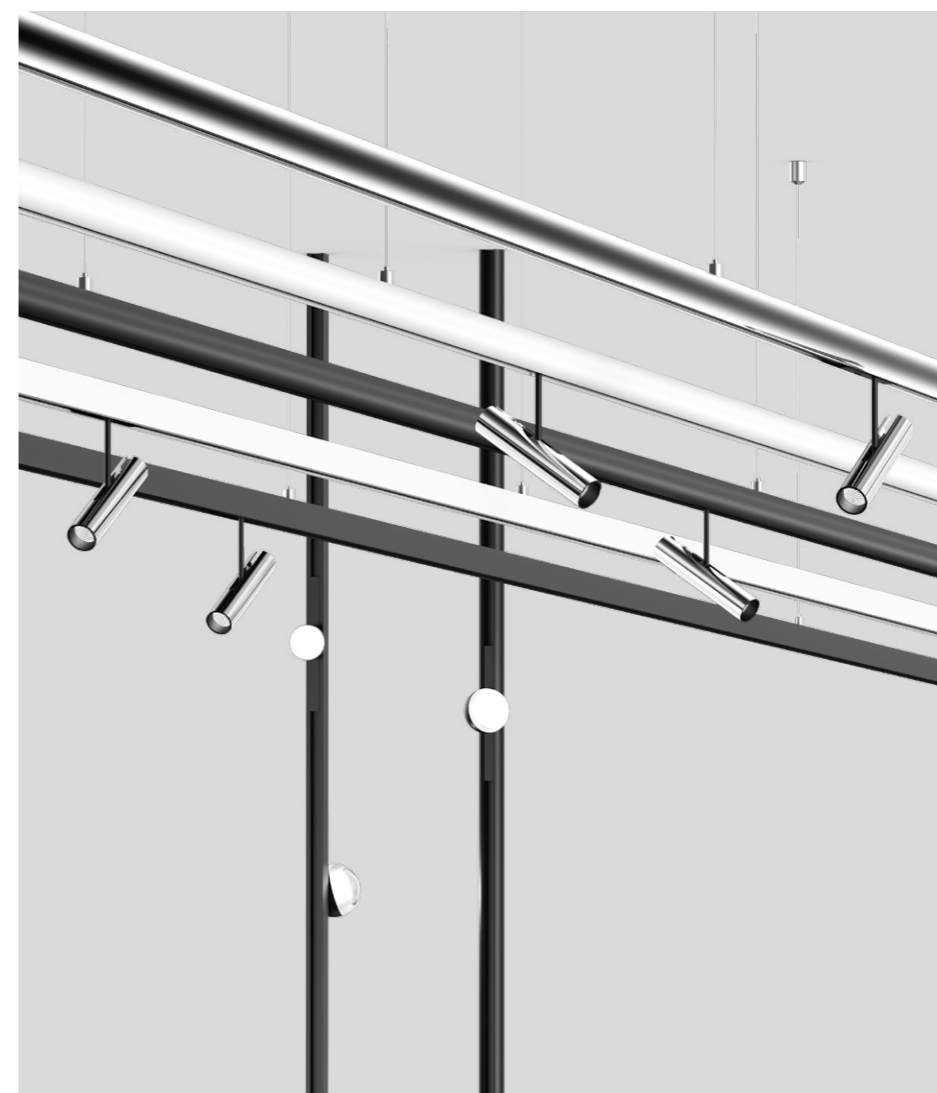
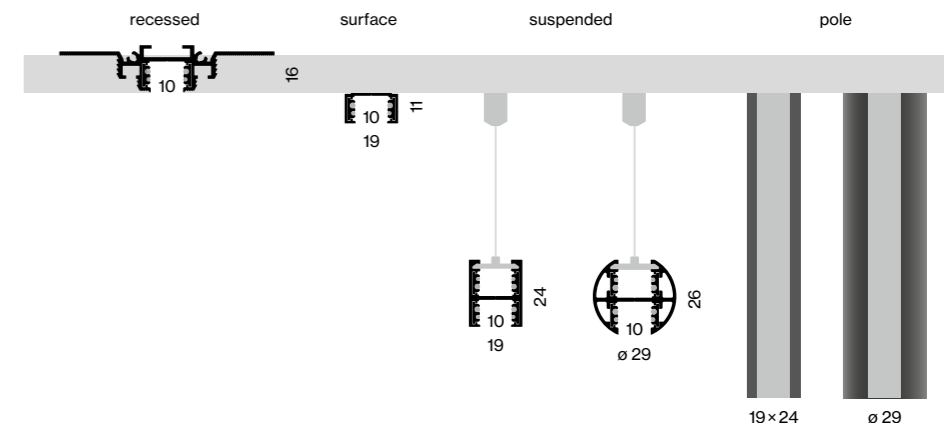

Colour variety

EN The tracks are available in the colours black and white, delivering discreet elegance. The round track comes additionally in chrome. In addition, for some insets you have the choice between the trend colours chrome, rose gold, gun metal, brushed aluminium and brushed brass.

IT Sobra eleganza: i binari sono disponibili nei colori bianco e nero. Il binario rotondo è proposto anche in cromo. Inoltre con alcuni inserti si possono scegliere colori trend come cromo, oro rosé, gun metal, alluminio spazzolato e ottone spazzolato.

Installation tracks

recessed square	●
surface square	○
suspended square	○
suspended round	○
pole square	○
pole round	○

Decorative insets

GIRA	○	●					
NOBA	○	●	●	●	●	●	●
TARO	○	●	●	●	●	●	●
TILA	○	●	●	●	●	●	●

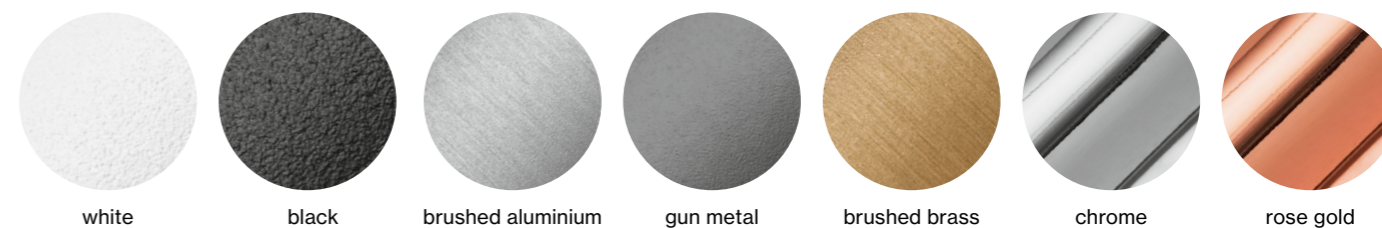

white

black

brushed aluminium

gun metal

brushed brass

chrome

rose gold



Mounting variety

EN With precise corners or harmonious curves, the MOVE IT 10 system sets no limits to creativity. Elegant insets for different applications make the track system even more flexible.

IT Che si tratti di angoli precisi o di curve armoniose, il sistema MOVE IT 10 non pone limiti alla creatività. Eleganti inserti per diverse applicazioni rendono il sistema ancora più flessibile.

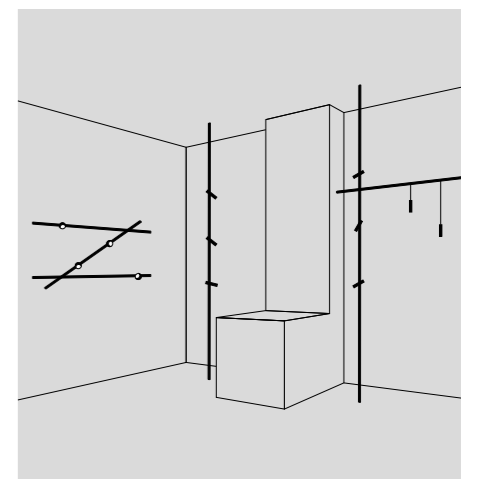
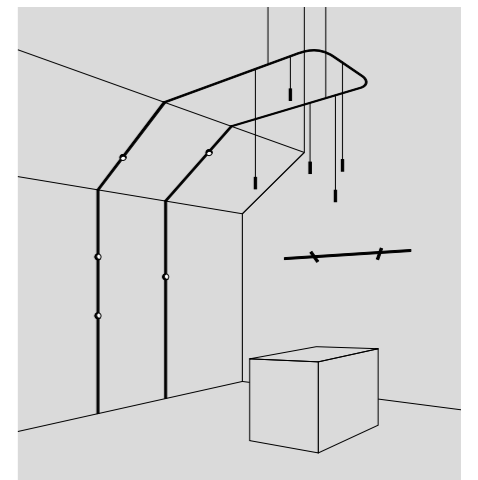
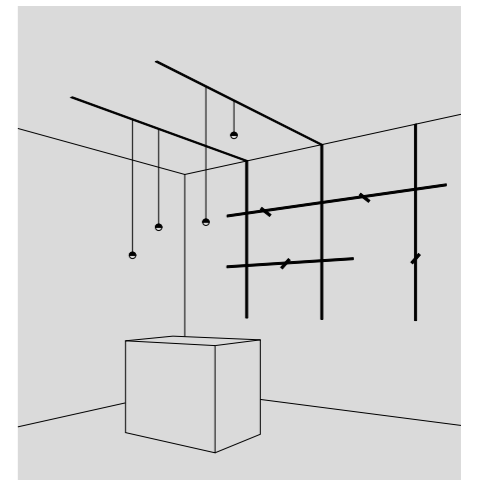

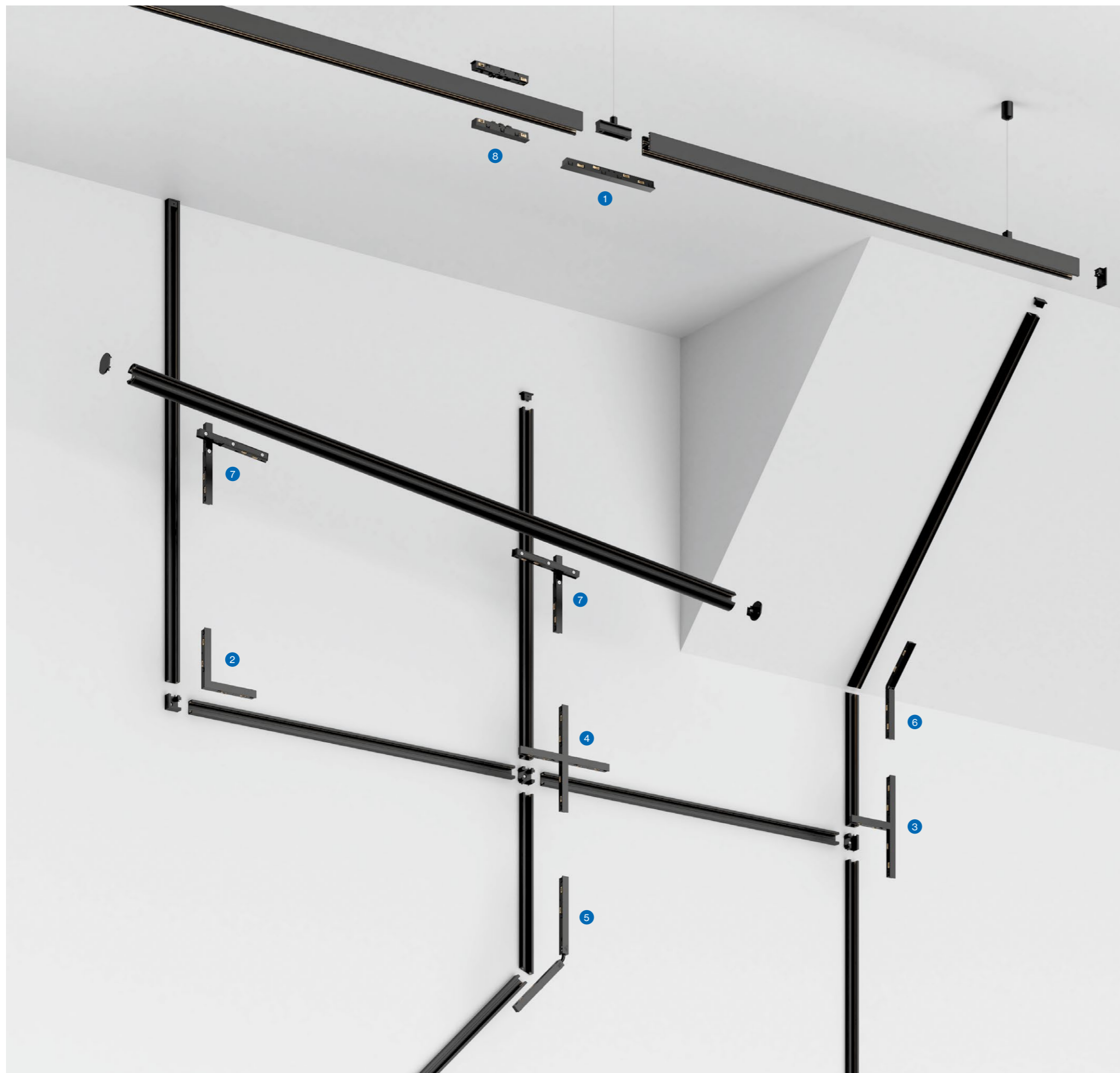

Connector overview

EN A large selection of different connectors – in L-, T-, X-shape – provides even more flexibility. With the Ceiling to Wall Connector, roof slopes with different angles can also be realised.

IT La flessibilità aumenta ulteriormente con l'ampia scelta di giunti: a L, a T, a X. A questi si aggiunge il Ceiling to Wall Connector che permette di realizzare pendenze dal tetto con angoli diversi.

1 Linear Connector



2 L-Connector



3 T-Connector



4 X-Connector



5 Flex Connector



6 Ceiling to Wall Connector



7 Level Connector



8 Pass Through Connector



EN With the Level Connector, two tracks that are placed on top of each other can now be mechanically and electrically connected to each other. This creates new application possibilities.

EN With the Pass Through Connector (patent pending) the direct and indirect light insets in the H-track can be electrically connected to each other.

IT Con il Level Connector si possono sovrapporre due binari collegandoli insieme meccanicamente ed elettricamente. Ne derivano nuove e interessanti applicazioni.

IT Un'altra possibilità è il Pass Through Connector, in attesa di brevetto: in questo caso gli inserti di luce diretta e indiretta nel binario ad H si collegano elettricamente tra loro.

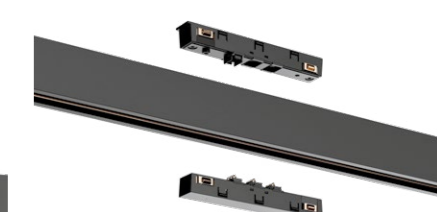
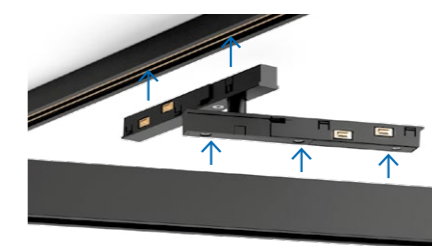

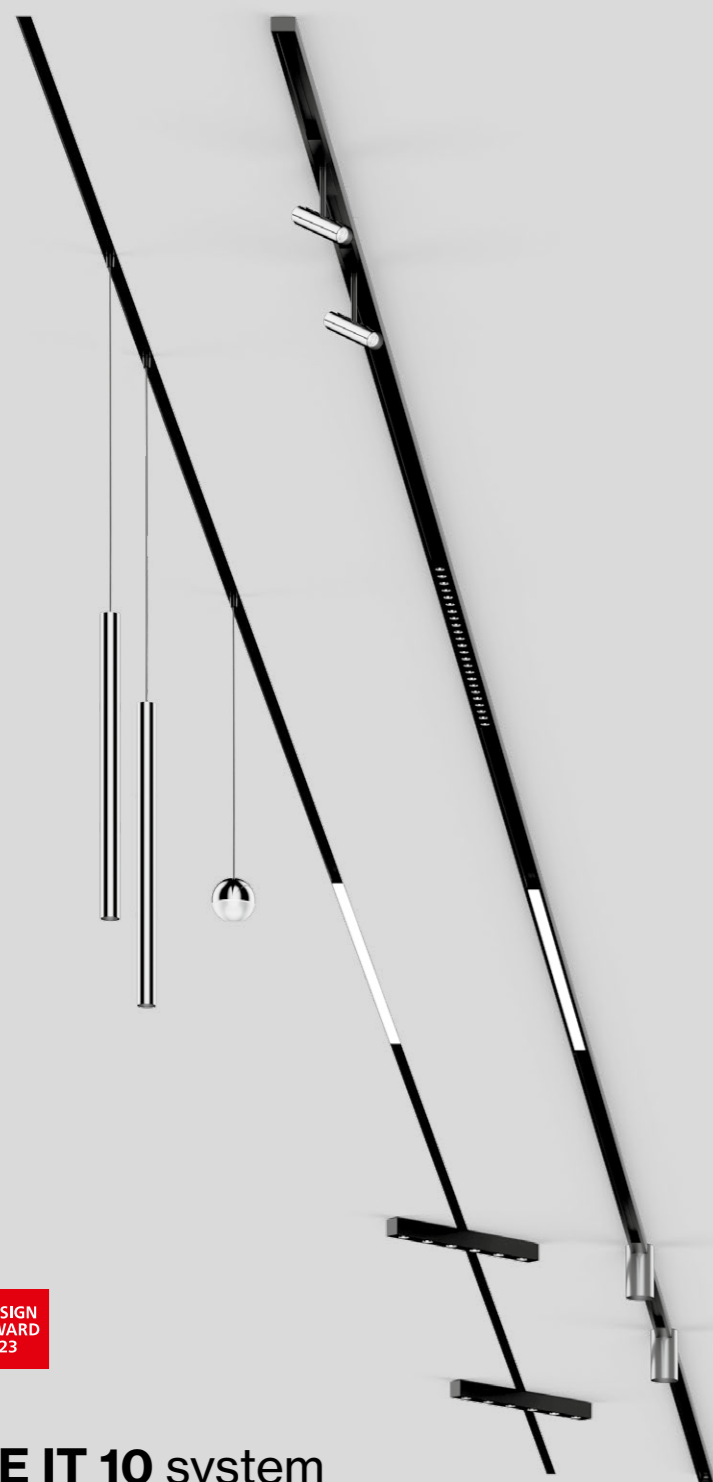

MOVE IT 10 system

recessed trimless/surface

Thin extruded aluminium profile with 16 mm (trimless) or 11 mm (surface) height and 10 mm width groove; optionally for trimless installation in plasterboard ceilings (wall or ceiling mounting) with 12.5mm ceiling thickness; MOVE IT 10 trimless profile with processing protection against penetration of filler; or for wall-/ceiling surface mounting; designed for continuous lighting systems; flexible system design through L, T or X connectors or by means of FLEX or LEVEL connectors; with integrated power track profile for take off of supply voltage and DALI-2 signal; surface anodised or powder coated; insets can be installed flexibly and without tools by means of clip mount

Profilo sottile in alluminio estruso con altezza di 16 mm (trimless) o di 11 mm (surface) e giunto largo 10 mm; a scelta per incasso a scomparsa in controsoffitti in cartongesso (montaggio a parete o a soffitto) con spessore soffitto di 12,5 mm; profilo MOVE IT 10 trimless con protezione di lavorazione contro la penetrazione dello stucco; o per montaggio a parete/soffitto; per sistemi di file continue; sistema con struttura flessibile grazie all'impiego di connettori a L, a T o a X oppure a connettori FLEX o LEVEL; con binario elettrico integrato per la riduzione della tensione di alimentazione e segnale DALI-2; superficie anodizzata o verniciatura a polvere; montaggio degli inserti flessibile e senza attrezzi grazie alla chiusura a clip

Quickinfo

2700K, 3000K, 4000K
CRI ≥ 90
L90 @ 50 000h
DALI-2

Types

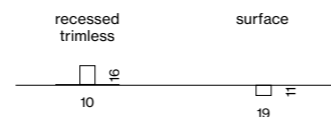

Configurations

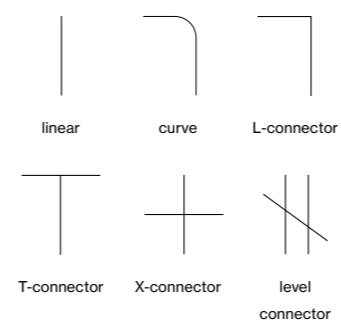

Colours



Order options

CONTROL

DALI-2

MATERIAL COLOUR

- traffic white RAL 9016 7
● jet black RAL 9005 8

Options on request

CONNECTOR

T connector mechanical
T connector electrical
X connector mechanical
X connector electrical

only for recessed trimless

MOVE IT 10 trimless



INSTALLATION TRACK

L (mm)

1100	channel
2100	channel
3100	channel
custom cut	channel

*incl. plasterin protection cover

END CAPS / CONNECTORS

TYPE

end caps (pair)	
linear connector electrical	
L connector electrical	
linear connector mechanical	
L connector mechanical	

more electrical and mechanical connectors see p. 19

MOVE IT 10 surface

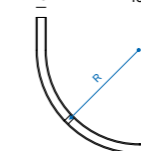
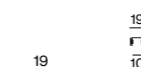
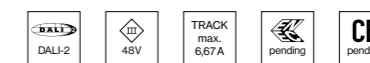

INSTALLATION TRACK

L (mm)

1100	channel
2100	channel
3100	channel
custom cut	channel
R 300	curve channel
R 500	curve channel

END CAPS / CONNECTORS

TYPE

end caps (pair)	
linear connector electrical	
L connector electrical	
T connector electrical	
X connector electrical	
linear connector mechanical	
L connector mechanical	
T connector mechanical	
X connector mechanical	

more electrical and mechanical connectors see p. 19

Accessories

BLIND COVER

L (mm)

1100	blind cover
2100	blind cover
3100	blind cover
custom cut	blind cover

ELECTRICAL ACCESSORIES

TYPE

power feeder (only for surface)	
internal power feeder (incl. cable 2000mm)	

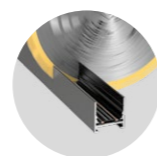
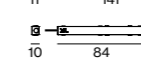
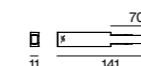

custom cut on building site





MOVE IT 10 system

suspended

Thin extruded aluminium profile with 10 mm width groove; choice of angular (38 mm height) or tubular (28 mm height) design; for suspended mounting (cable suspension, height adjustment without tools, incl. black feed); with integrated power track profile on both sides for take off of supply voltage and DALI-2 signal; power supply and DALI-2 signal for both power tracks with only one feed by means of pass-through connector; designed for continuous lighting systems; flexible system design through L, T or X connectors or by means of LEVEL connectors; surface anodised or powder coated; insets can be installed flexibly and without tools by means of clip mount

Profilo sottile in alluminio estruso con giunto largo 10 mm; possibilità di scelta tra design squadrato (altezza 38 mm) o tubolare (altezza 28 mm); per montaggio a sospensione (cavo di sospensione, regolazione in altezza senza attrezzi, cavo di alimentazione nero incluso); con binario elettrificato integrato su entrambi i lati per la presa della tensione di alimentazione e il segnale DALI-2; alimentazione e segnale DALI-2 per entrambi i binari elettrificati con un unico ingresso attraverso il connettore pass through; per sistemi di file continue; sistema con struttura flessibile grazie all'impiego di connettori a L, a T o a X oppure a connettori LEVEL; superficie anodizzata o verniciatura a polvere; montaggio degli inserti flessibile e senza attrezzi grazie alla chiusura a clip



Quickinfo

2700K, 3000K, 4000K
CRI ≥ 90
L90 @ 50 000h
DALI-2

Types

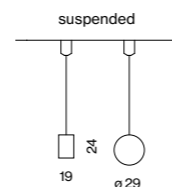

Configurations

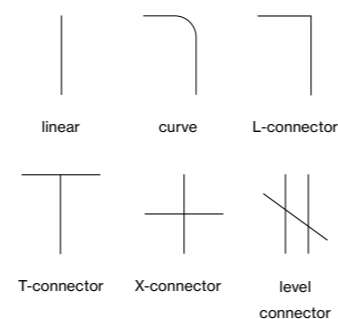

Colours



Order options

CONTROL
DALI-2

MATERIAL COLOUR
 ○ traffic white RAL 9016 7
 ● jet black RAL 9005 8

MATERIAL COLOUR
CABLE SUSPENSION
 ● chrome 4
 ● jet black RAL 9005 8

Options on request

MATERIAL COLOUR
MOVE IT 10 ROUND
 ● chrome

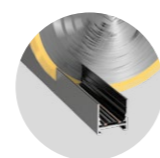

custom cut on building site

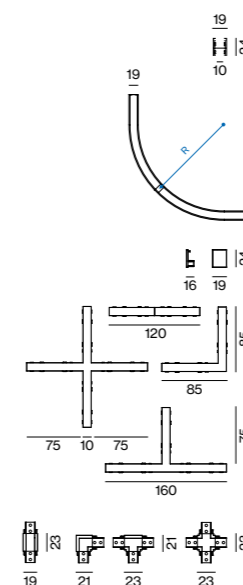

MOVE IT 10 square suspended

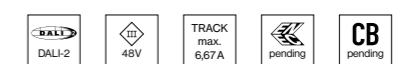

INSTALLATION TRACK

L (mm)		ORDER CODE
1100	channel	030-131303
2100	channel	030-131503
3100	channel	030-131703
custom cut	channel	E83630
R 300	curve channel	030-133103
R 500	curve channel	030-133203

END CAPS / CONNECTORS

TYPE	ORDER CODE
end caps (pair)	030-132001
linear connector electrical	030-210113
L connector electrical	030-211113
T connector electrical	030-212113
X connector electrical	030-213113
linear connector mechanical	030-133401
L connector mechanical	030-133501
T connector mechanical	030-133601
X connector mechanical	030-133701

more electrical and mechanical connectors see page 19

MOVE IT 10 round suspended

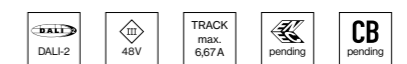

INSTALLATION TRACK

L (mm)		ORDER CODE
1100	channel	030-141303
2100	channel	030-141503
3100	channel	030-141703
custom cut	channel	E83640
R 300	curve channel	030-143103
R 500	curve channel	030-143203

END CAPS / CONNECTORS

TYPE	ORDER CODE
end caps (pair)	030-142001
linear connector electrical	030-210113
L connector electrical	030-211113
T connector electrical	030-212113
X connector electrical	030-213113
linear connector mechanical	030-143401
L connector mechanical	030-143501
T connector mechanical	030-143601
X connector mechanical	030-143701

more electrical and mechanical connectors see page 19

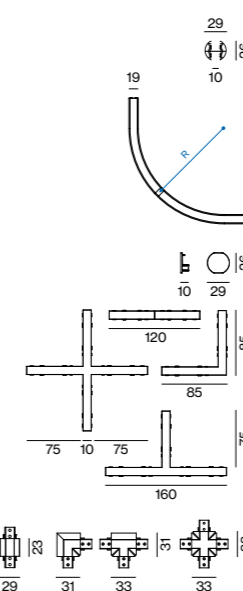

Accessories

BLIND COVER see page 17

INDIRECT LIGHT INSET see page 17

CABLE SUSPENSION / CANOPY / ELECTRICAL ACCESSORIES

TYPE	L (mm)	ORDER CODE
cable suspension	1500	030-223001
cable susp. linear connector	1500	030-221001
cable susp. linear conn. electrical	1500	030-222001
canopy square	90-90-22	005-231121
canopy round	∅90-22	005-260003
internal power feeder (incl. cable 2000mm)		030-252503
pass through connector electrical (pair)		030-217113

more electrical and mechanical connectors see page 19





MOVE IT 10 system

pole

Thin extruded aluminium profile with 10 mm width groove; choice of angular (38 mm height) or tubular (28 mm height) design; for vertical and horizontal mounting; easy installation of the mounting set, incl. feed; with integrated power track profile on both sides for take off of supply voltage and DALI-2 signal; power supply and DALI-2 signal for both power tracks with only one feed by means of pass-through connector; designed for continuous lighting systems; flexible system design through L, T or X connectors or by means of LEVEL connectors; surface anodised or powder coated; insets can be installed flexibly and without tools by means of clip mount

Profilo sottile in alluminio estruso con giunto largo 10 mm; possibilità di scelta tra design squadrato (altezza 38 mm) o tubolare (altezza 28 mm); per montaggio verticale e orizzontale; facile installazione del set di montaggio, alimentatore incluso; con binario elettrificato integrato su entrambi i lati per la presa della tensione di alimentazione e il segnale DALI-2; alimentazione e segnale DALI-2 per entrambi i binari elettrificati con un unico ingresso attraverso il connettore pass through; per sistemi di file continue; sistema con struttura flessibile grazie all'impiego di connettori a L, a T o a X oppure a connettori LEVEL; superficie anodizzata o verniciatura a polvere; montaggio degli inserti flessibile e senza attrezzi grazie alla chiusura a clip

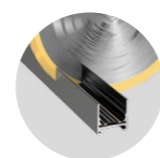

custom cut on building site

Quickinfo

2700K, 3000K, 4000K
CRI ≥ 90
L90 @ 50 000h
DALI-2

Types

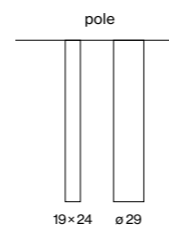

Mounting types

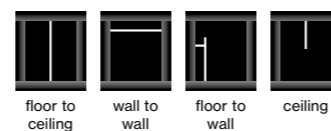

Colours



Order options

COLOUR TEMPERATURE	
2700K	4
3000K	5
4000K	6

CONTROL

DALI-2

MATERIAL COLOUR

<input type="radio"/> traffic white RAL 9016	7
<input checked="" type="radio"/> jet black RAL 9005	8

Options on request

MATERIAL COLOUR
MOVE IT 10 ROUND

chrome

MOVE IT 10 square pole



19
H
10

INSTALLATION TRACK

L (mm)		ORDER CODE
1100	channel	030-131303
2100	channel	030-131503
3100	channel	030-131703
custom cut	channel	E83630

19x24
H
46

MOUNTING SET

TYPE	ORDER CODE
floor to ceiling set (pair)	030-134101
wall to wall set (pair)	030-134101
floor to wall set (wall bracket 400mm incl. end cap)	030-134201
ceiling set (incl. end cap)	030-134301

MOVE IT 10 round pole



29
H
10

INSTALLATION TRACK

L (mm)		ORDER CODE
1100	channel	030-141303
2100	channel	030-141503
3100	channel	030-141703
custom cut	channel	E83640

29
H
46

MOUNTING SET

TYPE	ORDER CODE
floor to ceiling set (pair)	030-144101
wall to wall set (pair)	030-144101
floor to wall set (wall bracket 400mm incl. end cap)	030-144201
ceiling set (incl. end cap)	030-144301

LIGHT INSET 10

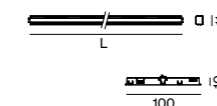

INDIRECT incl. feeder

INS. POWER	COLOUR TEMP.	LUM. FLUX	L (mm)	ORDER CODE
15 W	2700 K	1370 lm	1000	030-6330::38B
	3000 K	1450 lm		
	4000 K	1530 lm		
30 W	2700 K	2750 lm	2000	030-6370::38B
	3000 K	2900 lm		
	4000 K	3050 lm		

Accessories

BLIND COVER

L (mm)		ORDER CODE
1100	blind cover	030-100301
2100	blind cover	030-100501
3100	blind cover	030-100701
custom cut	blind cover	E83600

ELECTRICAL ACCESSORIES

TYPE	ORDER CODE
internal power feeder (incl. cable 2000 mm)	030-252503
pass through connector electrical (pair)	030-217113

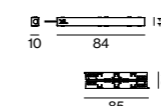

INSET POWER is the current consumption excluding any ballast
LUMINOUS FLUX value calculated for CRI ≥ 90, colour black



ELECTRICAL accessories

MOVE IT 10 system

EN Mechanical and electrical connectors to MOVE IT 10 system; in L-, T- or X-shape; or FLEX, CEILING TO WALL or LEVEL connectors, as well as PASS THROUGH connectors; for flexible system design; different converters for the entire MOVE IT system

IT Connettori meccanici ed elettrici per il sistema MOVE IT 10; a L, a T o a X; oppure connettori FLEX, CEILING TO WALL o LEVEL, nonché connettori PASS THROUGH; per composizioni flessibili; diversi convertitori per l'intero sistema MOVE IT

Types

- 1 Linear Connector
- 2 L-Connector
- 3 T-Connector
- 4 X-Connector
- 5 Flex Connector
- 6 Ceiling to Wall Connector
- 7 Level Connector
- 8 Pass Through Connector

Configurations

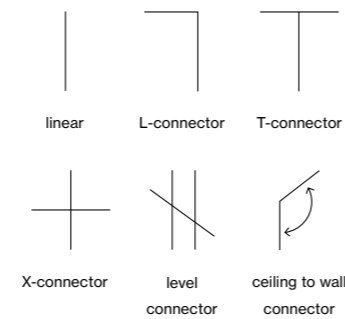

Colours



Order options

CONNECTOR MECHANICAL	T
recessed*	1
surface	2
suspended square	3
suspended round	4

*T- and X-connector on request

CONTROL

DALI-2	
--------	--

MATERIAL COLOUR

○ traffic white* RAL 9016	7
● jet black RAL 9005	8

*not for mechanical recessed trimless

Options on request

CONNECTOR

T connector electrical	
T connector mechanical	
X connector electrical	
X connector mechanical	

only for recessed trimless

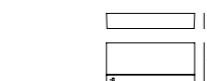
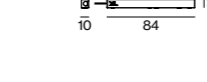
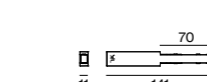
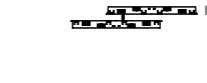
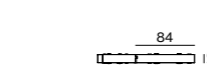
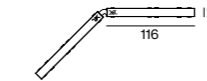
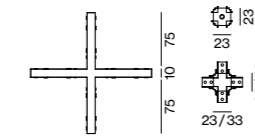
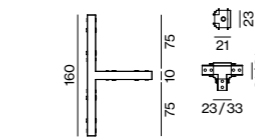
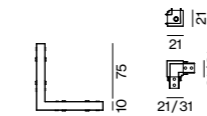

Electrical accessories

LINEAR CONNECTOR

TYPE	ORDER CODE
linear connector electrical	030-210113
linear connector mechanical	030-1T3401

L CONNECTOR

TYPE	ORDER CODE
L connector electrical	030-211113
L connector mechanical	030-1T3501

T CONNECTOR

TYPE	ORDER CODE
T connector electrical	030-212113
T connector mechanical	030-1T3601

X CONNECTOR

TYPE	ORDER CODE
X connector electrical	030-213113
X connector mechanical	030-1T3701

FLEX CONNECTOR

TYPE	ORDER CODE
flex connector electrical	030-214113

CEILING TO WALL CONNECTOR

TYPE	ORDER CODE
ceiling to wall connector electrical	030-216113

LEVEL CONNECTOR

TYPE	ORDER CODE
level connector electrical	030-215113

PASS THROUGH CONNECTOR

TYPE	ORDER CODE
pass through connector electrical (pair)	030-217113

electrical connection from direct to indirect and vice versa

POWER FEEDER

TYPE	ORDER CODE
power feeder (only for surface)	030-252303
internal power feeder (incl. cable 2000mm)	030-252503

POWER SUPPLY EXTERNAL supply 220-240V AC, 48V, 50-60Hz

TYPE	EFFICIENCY	MOUNTING	L-W-H (mm)	ORDER CODE
60W PC II η88%	external	163-43-32	002-62133	
150W PC II η92%	external	350-30-18	002-62135	
250W PC II η93%	external	400-40-22	002-62139	

ENEC approved, incl. feeder cable 2000mm

POWER SUPPLY BASIC 48V

220-240V | 50-60Hz | PC II | Lifetime @ 120W, 45° ambient temp. cascable max. 3 devices

TYPE	EFFICIENCY/LIFETIME	W-H-D (mm)	ORDER CODE
160W η94.5% / > 100.000h		72-90-63	005-6520210

DIN RAIL POWER SUPPLY PRO 48V

220-240V | 50-60Hz | PC II | MTBF @ 55° ambient temperature cascable max. 5 devices (240W) or 3 devices (480W)

TYPE	EFFICIENCY/MTBF	W-H-D (mm)	ORDER CODE
240W η92% / > 400.000h		60-125-100	005-6220110
480W η93% / > 350.000h		120-125-100	005-6220210



Quickinfo

2700 K, 3000 K, 4000 K
 CRI ≥ 90
 up to 105 lm/W
 DALI-2

Types

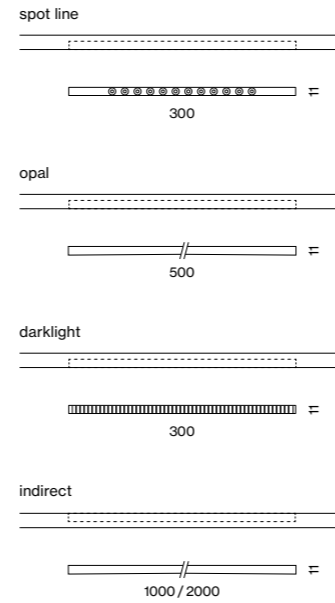

Colour



Light distributions

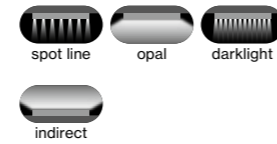

Order options

COLOUR TEMPERATURE	
2700K	4
3000K	5
4000K	6

CONTROL
 DALI-2

MATERIAL COLOUR
 ● jet black RAL 9005

LIGHT OPTIC
 spot line
 opal high performance
 darklight
 indirect

LIGHT INSET 10

SPOT LINE

INS. POWER	COLOUR TEMP.	LUM. FLUX	L (mm)	ORDER CODE
8.5 W	2700 K	420 lm	300	0 30 - 6 1 1 0 :: 3 8 M
	3000 K	460 lm		
	4000 K	480 lm		

OPAL HIGH PERFORMANCE

INS. POWER	COLOUR TEMP.	LUM. FLUX	L (mm)	ORDER CODE
5 W	2700 K	520 lm	500	0 30 - 6 1 2 0 :: 3 8 H
	3000 K	520 lm		
	4000 K	525 lm		

DARKLIGHT

INS. POWER	COLOUR TEMP.	LUM. FLUX	L (mm)	ORDER CODE
5.7 W	2700 K	280 lm	300	0 30 - 6 2 1 0 :: 3 8 M
	3000 K	280 lm		
	4000 K	285 lm		

INDIRECT incl. feeder

INS. POWER	COLOUR TEMP.	LUM. FLUX	L (mm)	ORDER CODE
15 W	2700 K	1370 lm	1000	0 30 - 6 3 3 0 :: 3 8 M
	3000 K	1450 lm		
	4000 K	1530 lm		
30 W	2700 K	2750 lm	2000	0 30 - 6 3 7 0 :: 3 8 M
	3000 K	2900 lm		
	4000 K	3050 lm		

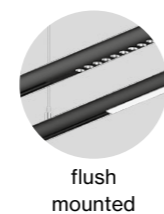

INSET POWER is the current consumption excluding any ballast
LUMINOUS FLUX value calculated for CRI ≥ 90, colour black



SPOT LINE / OPAL / DARKLIGHT

linear inset 10

Private Residence
Visualisation





TILA
decorative inset 10

Quickinfo

2700 K, 3000 K, 4000 K
CRI ≥ 90
up to 81 lm/W
DALI-2

Types

adjustable rod

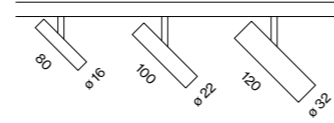

suspended

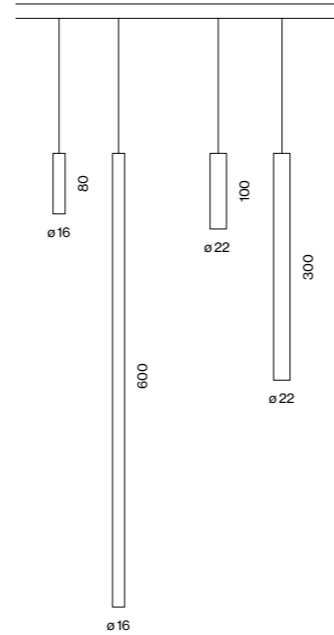

Colours



Light distributions

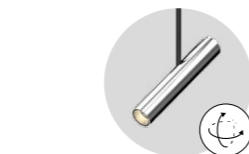
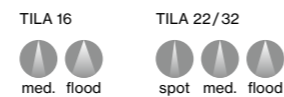

365° rotatable
135° tiltable

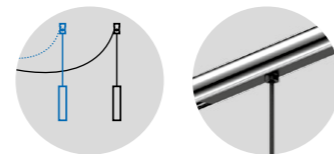

free positioning by
cable and hook

flush adapter
mounting

Order options

HOUSING HEIGHT TILA 16	L
80 mm	0
600 mm	1

HOUSING HEIGHT TILA 22	L
100 mm	3
300 mm	4

COLOUR TEMPERATURE	☼
2700 K	4
3000 K	5
4000 K	6

CONTROL

DALI-2

MATERIAL COLOUR

○ traffic white RAL 9016	7
● jet black RAL 9005	8
● brushed aluminium	6
● chrome	4

MATERIAL COLOUR

ACCESSORIES	■
○ traffic white RAL 9016	7
● jet black RAL 9005	8

BEAM ANGLE TILA 16

medium 20°	M
flood 40°	F

BEAM ANGLE TILA 22/32

spot 14°	S
medium 24°	M
flood 45°	F

Options on request

MATERIAL COLOUR

● gun metal	
● brushed brass	
● rose gold	

INSET POWER is the current consumption excluding any ballast
LUMINOUS FLUX value calculated for CRI ≥ 90, colour white, medium

TILA 16

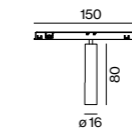

ADJUSTABLE

INSET POWER	COLOUR TEMP.	LUMINOUS FLUX	ORDER CODE
5 W	2700 K	230 lm	030-6500::3▲
	3000 K	240 lm	
	4000 K	250 lm	

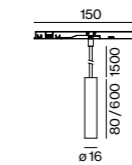

SUSPENDED

INSET POWER	COLOUR TEMP.	LUMINOUS FLUX	ORDER CODE
5 W	2700 K	230 lm	030-66L0::3▲
	3000 K	240 lm	
	4000 K	250 lm	

TILA 22

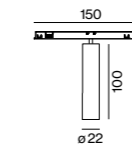

ADJUSTABLE

INSET POWER	COLOUR TEMP.	LUMINOUS FLUX	ORDER CODE
10.5 W	2700 K	415 lm	030-6530::3▲
	3000 K	440 lm	
	4000 K	460 lm	

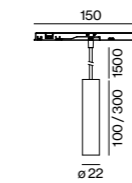

SUSPENDED

INSET POWER	COLOUR TEMP.	LUMINOUS FLUX	ORDER CODE
10.5 W	2700 K	415 lm	030-66L0::3▲
	3000 K	440 lm	
	4000 K	460 lm	

TILA 32

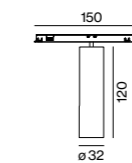

ADJUSTABLE

INSET POWER	COLOUR TEMP.	LUMINOUS FLUX	ORDER CODE
11 W	2700 K	720 lm	030-6560::3▲
	3000 K	850 lm	
	4000 K	900 lm	

Mounting accessories

HOOK ceiling mounted

TYPE	Ø-H (mm)	ORDER CODE
hook	16-30	030-100001■

Optical accessories

HONEYCOMB LOUVER

TYPE	Ø-H (mm)	ORDER CODE
TILA 22	20-3	007-1965118
TILA 32	30-3	007-1965168

Jewellery Shop
Visualisation



Private Residence
Visualisation



Private Residence
Visualisation



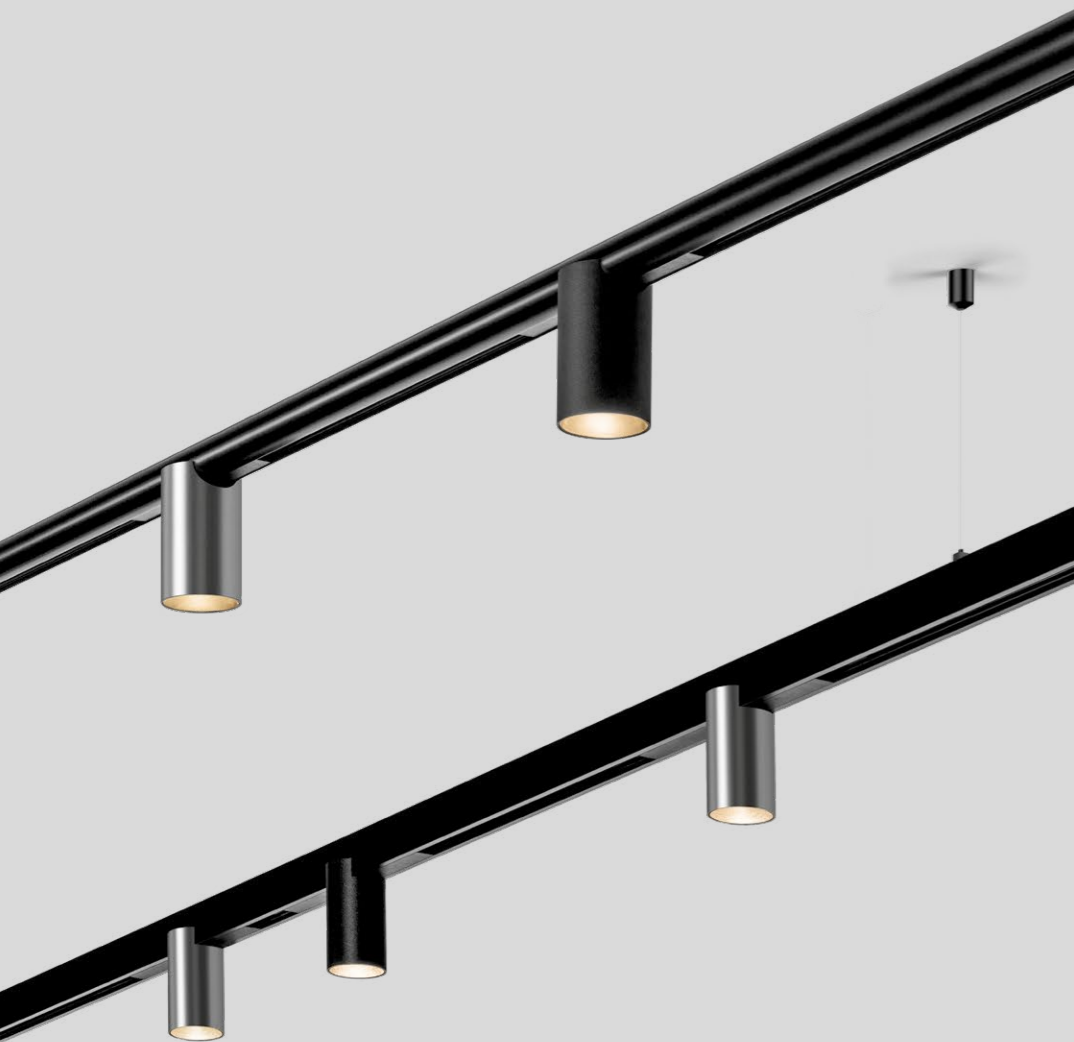

TARO
decorative inset 10

Quickinfo

2700 K, 3000 K, 4000 K
CRI ≥ 90
up to 83lm/W
DALI-2

Types

square track

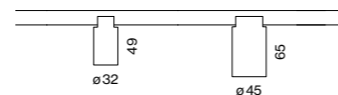

round track

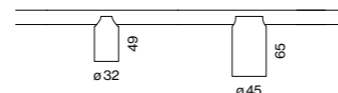

Colours



Light distributions

TARO 32



TARO 45

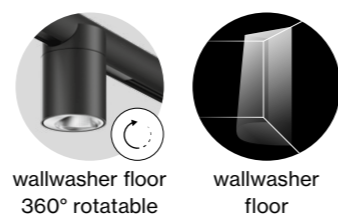

Order options

COLOUR TEMPERATURE	
2700 K	4
3000 K	5
4000 K	6

CONTROL	
DALI-2	

MATERIAL COLOUR	
○ traffic white RAL 9016	7
● jet black RAL 9005	8
● brushed aluminium	6
● chrome	4

BEAM ANGLE TARO 32	
spot 18°	S
medium 23°	M
flood 37°	F

BEAM ANGLE TARO 45	
medium 24°	M
flood 39°	F

Options on request

MATERIAL COLOUR	
● gun metal	
● brushed brass	
● rose gold	

TARO 32

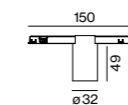
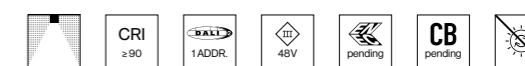

DOWNLIGHT SQUARE TRACK

INSET POWER	COLOUR TEMP.	LUMINOUS FLUX	ORDER CODE
11 W	2700 K	720 lm	030-6700::3▲
	3000 K	860 lm	
	4000 K	900 lm	

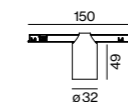

DOWNLIGHT ROUND TRACK

INSET POWER	COLOUR TEMP.	LUMINOUS FLUX	ORDER CODE
11 W	2700 K	720 lm	030-6740::3▲
	3000 K	860 lm	
	4000 K	900 lm	

TARO 45

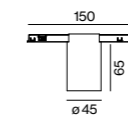

DOWNLIGHT SQUARE TRACK

INSET POWER	COLOUR TEMP.	LUMINOUS FLUX	ORDER CODE
15 W	2700 K	1000 lm	030-6710::3▲
	3000 K	1100 lm	
	4000 K	1150 lm	

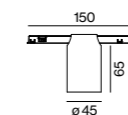

DOWNLIGHT ROUND TRACK

INSET POWER	COLOUR TEMP.	LUMINOUS FLUX	ORDER CODE
15 W	2700 K	1000 lm	030-6750::3▲
	3000 K	1100 lm	
	4000 K	1150 lm	

TARO 45 wallwasher floor

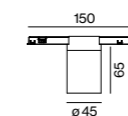

DOWNLIGHT SQUARE TRACK

INSET POWER	COLOUR TEMP.	LUMINOUS FLUX	ORDER CODE
9 W	2700 K	530 lm	030-6780::3▲W
	3000 K	570 lm	
	4000 K	580 lm	

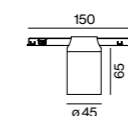

DOWNLIGHT ROUND TRACK

INSET POWER	COLOUR TEMP.	LUMINOUS FLUX	ORDER CODE
9 W	2700 K	530 lm	030-6790::3▲W
	3000 K	570 lm	
	4000 K	580 lm	

Optical accessories

HONEYCOMB LOUVER

TYPE	Ø-H (mm)	ORDER CODE
TARO 32	30.4	007-1965168
TARO 45	42.3	007-1965188

INSET POWER is the current consumption excluding any ballast
LUMINOUS FLUX value calculated for CRI ≥ 90, colour white, medium

Jewellery Shop
Visualisation



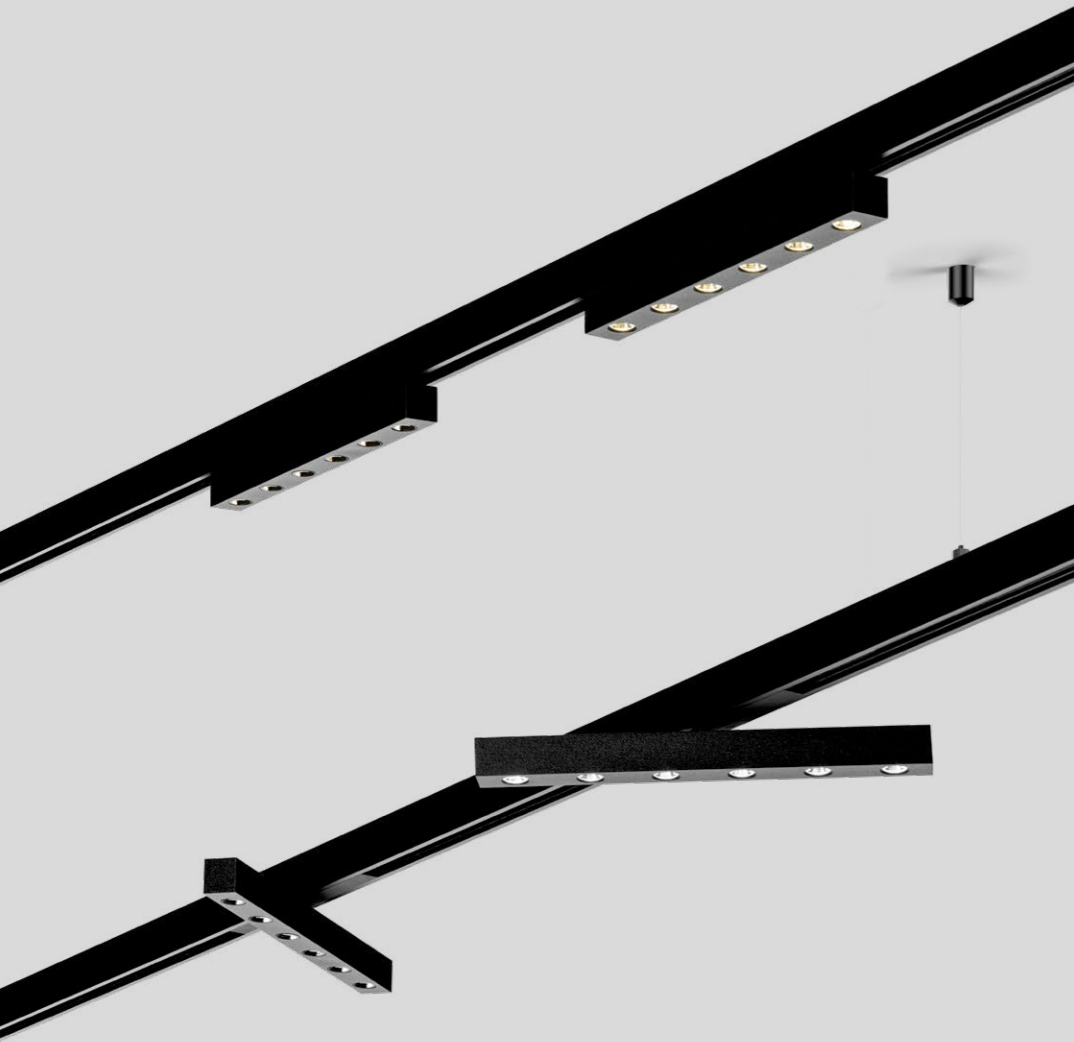

Quickinfo

2700 K, 3000 K, 4000 K
 CRI ≥ 90
 up to 79 lm/W
 DALI-2

Type

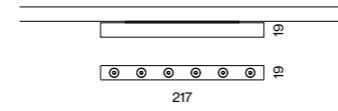

Colours



Light distributions



Order options

COLOUR TEMPERATURE	
2700K	4
3000K	5
4000K	6

CONTROL

DALI-2

MATERIAL COLOUR

<input type="radio"/> traffic white RAL 9016	7
<input checked="" type="radio"/> jet black RAL 9005	8

BEAM ANGLE

medium 20°	M
flood 40°	F

GIRA

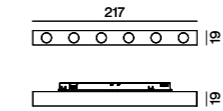

DOWNLIGHT ROTATABLE

INSET POWER	COLOUR TEMP.	LUMINOUS FLUX	ORDER CODE
19 W	2700 K	1350 lm	0 3 0 - 6 4 1 0 :: 3 ▣ ▲
	3000 K	1400 lm	
	4000 K	1450 lm	

GIRA wallwasher floor

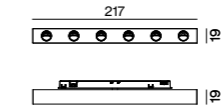

WALLWASHER FLOOR ROTATABLE

INSET POWER	COLOUR TEMP.	LUMINOUS FLUX	ORDER CODE
11 W	2700 K	730 lm	0 3 0 - 6 4 3 0 :: 3 ▣ W
	3000 K	770 lm	
	4000 K	800 lm	



GIRA
 decorative inset 10

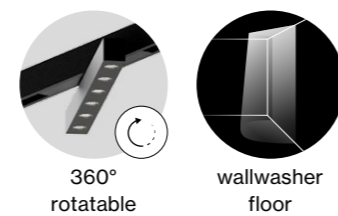

INSET POWER is the current consumption excluding any ballast
LUMINOUS FLUX value calculated for CRI ≥ 90, colour white, medium

Private Residence
Visualisation





Quickinfo

2700 K, 3000 K, 4000 K
 CRI ≥ 90
 up to 110 lm/W
 DALI-2

Types

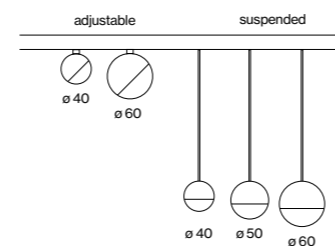

Colours



Light distribution



direct



365° rotatable
 90° tiltable

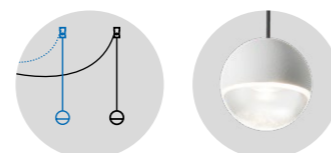

free positioning by
 cable and hook

high quality
 glass lens

Order options

COLOUR TEMPERATURE	
2700 K	4
3000 K	5
4000 K	6

CONTROL

DALI-2

MATERIAL COLOUR

○ traffic white RAL 9016	7
● jet black RAL 9005	8
● brushed aluminium	6
● chrome	4

MATERIAL COLOUR

ACCESSORIES

○ traffic white RAL 9016	7
● jet black RAL 9005	8

BEAM ANGLE

direct 80°

Options on request

MATERIAL COLOUR

- gun metal
- brushed brass
- rose gold

NOBA 40

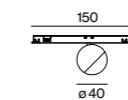

SPOTLIGHT ADJUSTABLE

INSET POWER	COLOUR TEMP.	LUMINOUS FLUX	ORDER CODE
4.5 W	2700 K	465 lm	030-6800::3
	3000 K	480 lm	
	4000 K	500 lm	

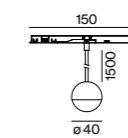

DOWNLIGHT SUSPENDED

INSET POWER	COLOUR TEMP.	LUMINOUS FLUX	ORDER CODE
4.5 W	2700 K	465 lm	030-6900::3
	3000 K	480 lm	
	4000 K	500 lm	

NOBA 50

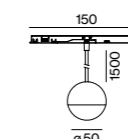

DOWNLIGHT SUSPENDED

INSET POWER	COLOUR TEMP.	LUMINOUS FLUX	ORDER CODE
9 W	2700 K	695 lm	030-6910::3
	3000 K	725 lm	
	4000 K	760 lm	

NOBA 60

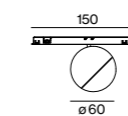

SPOTLIGHT ADJUSTABLE

INSET POWER	COLOUR TEMP.	LUMINOUS FLUX	ORDER CODE
10 W	2700 K	715 lm	030-6820::3
	3000 K	745 lm	
	4000 K	780 lm	

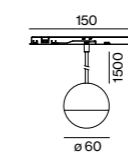

DOWNLIGHT SUSPENDED

INSET POWER	COLOUR TEMP.	LUMINOUS FLUX	ORDER CODE
10 W	2700 K	715 lm	030-6920::3
	3000 K	745 lm	
	4000 K	780 lm	

Mounting accessories



HOOK ceiling mounted

TYPE	Ø-H (mm)	ORDER CODE
hook	16-30	030-100001



NOBA

decorative inset 10

INSET POWER is the current consumption excluding any ballast
LUMINOUS FLUX value calculated for CRI ≥ 90, colour white

Private Residence
Visualisation

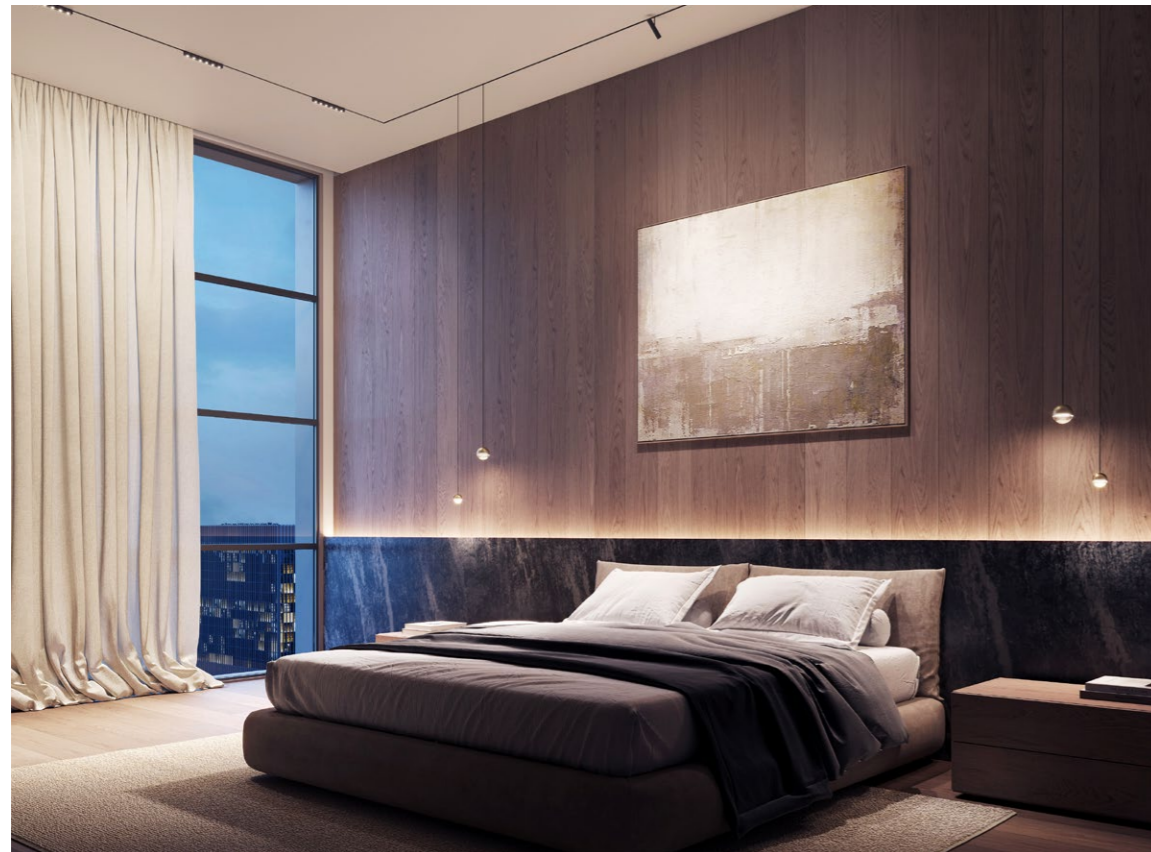

Perfect allrounder

TUBO/SETA 60 CONEX system

EN TUBO and SETA make a name for themselves as uniform and minimalist lighting system luminaires that can be flexibly joined by various connecting elements. The luminaires are available for wall and ceiling mounting, as well as in suspended pendant versions. Thanks to their opal cover, the TUBO system luminaire delivers uniform ambient illumination and the characteristic beam angle of up to 340° ensures a soft ceiling illumination that helps build a pleasant room atmosphere. SETA system luminaire's reflectors are particularly noteworthy and have been optimised for office spaces and designed for working at screens. The indirect light component creates a pleasant, homogeneous ceiling illumination for every work area. The CONEX connector (patent pending) grants the system a high degree of flexibility. As a mechanical and electrical L-, T-, and X-shaped connecting element, it allows implementation of geometric shapes over several levels.

IT TUBO & SETA sono apparecchi in sistema di aspetto unitario e minimalista. Si possono collegare reciprocamente con flessibilità grazie a diversi tipi di giunti. Gli apparecchi sono previsti per montaggio a parete, soffitto e sospensione. Con il rifratore opale l'apparecchio TUBO diffonde una luminosità uniforme, mentre il caratteristico angolo di emissione fino a 340° illumina leggermente soffitto diffondendo un'atmosfera piacevole. Vanno poi menzionati i riflettori dell'apparecchio SETA, ottimizzati appositamente per gli uffici e concepiti per lavorare al computer. La componente indiretta illumina il soffitto con un effetto piacevole e omogeneo in ogni zona di lavoro. Il giunto CONEX (in attesa di brevetto) conferisce al sistema un elevato grado di flessibilità. Si tratta di un collegamento meccanico ed elettrico a L, T e X, con cui si possono realizzare forme geometriche su più livelli.

Type



60

Mountings

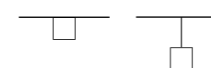

surface

suspended

System configurations



linear

L

T

X

Light distributions

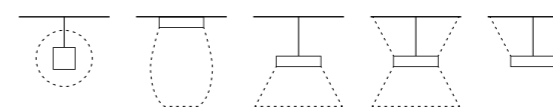

opal

reflector
(UGR ≤ 19)

direct

direct
indirect

indirect

Connector CONEX

EN The patent pending CONEX connector system for the TUBO 60 system now offers even more design freedom. With the flexible lighting system, geometric shapes or exciting light sculptures can be created. Thanks to the mechanical and electrical connectors in L, T and X shapes, a visually uniform lighting system is created. In combination with the SETA system, various areas of application are possible - whether as corridor, office luminaire or visual guidance system.

IT Da oggi la libertà compositiva cresce ulteriormente con la giunzione CONEX per TUBO 60, in attesa di brevetto. La sua flessibilità permette di creare forme geometriche o interessanti sculture di luce. Con i giunti meccanici ed elettrici a L, T e X, si riesce a comporre un impianto visivamente unitario. In abbinamento al sistema SETA sono possibili molte altre destinazioni: ad esempio corridoi e uffici oppure sistemi di guida visiva.

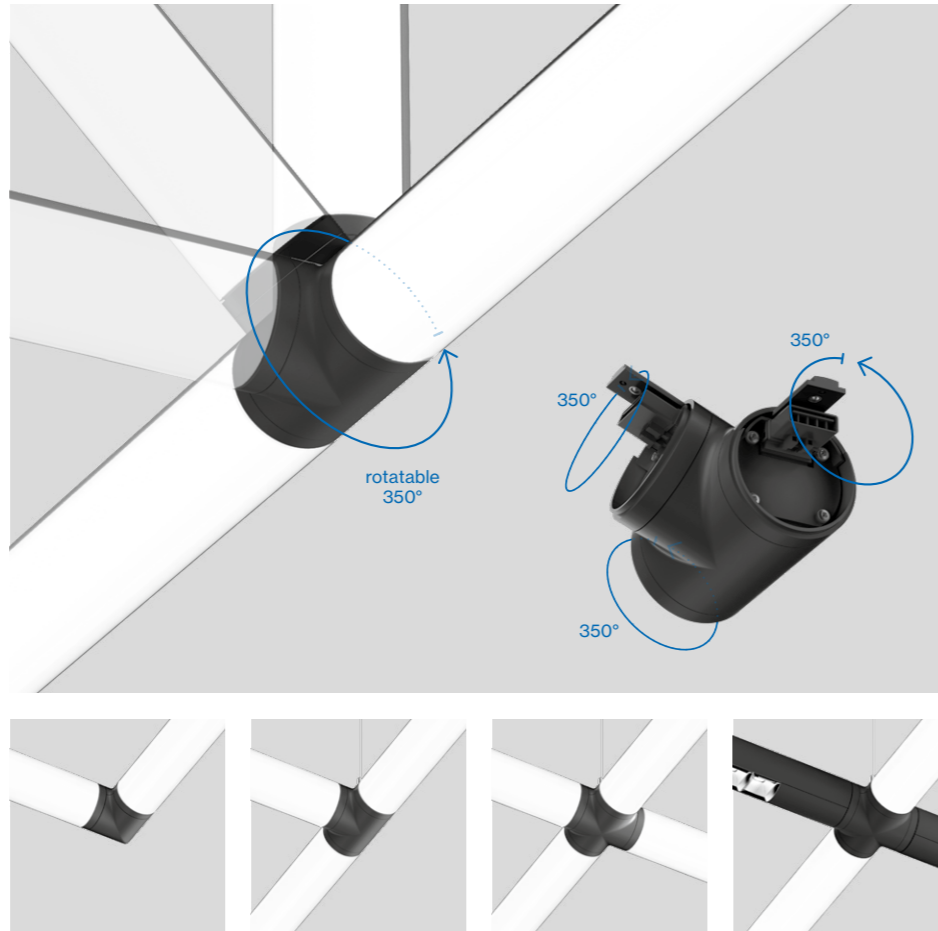

Easy mounting

EN CONEX system luminaires are electrically and mechanically connected by a simple plug-in connection. This makes the installation of a complex lighting system simple, quick, and straightforward.

IT Il collegamento elettrico e meccanico degli apparecchi CONEX si effettua con semplici innesti. Pertanto installare un sistema in realtà complesso diventa semplice, veloce e senza complicazioni.

340° light distribution

EN With its 340° beam pattern and opal cover, TUBO System delivers homogeneous illumination as well as slight ceiling brightening. This makes the system luminaire perfect for places where pleasant ambient lighting is desired, such as reception areas, corridors, or foyers.

IT Con un fascio di emissione a 340° e il riflettore opale, TUBO System diffonde una luminosità omogenea illuminando leggermente anche il soffitto. Pertanto l'apparecchio risulta perfetto ovunque si cerchi una gradevole illuminazione di sfondo, ad esempio in reception, corridoi o foyer.

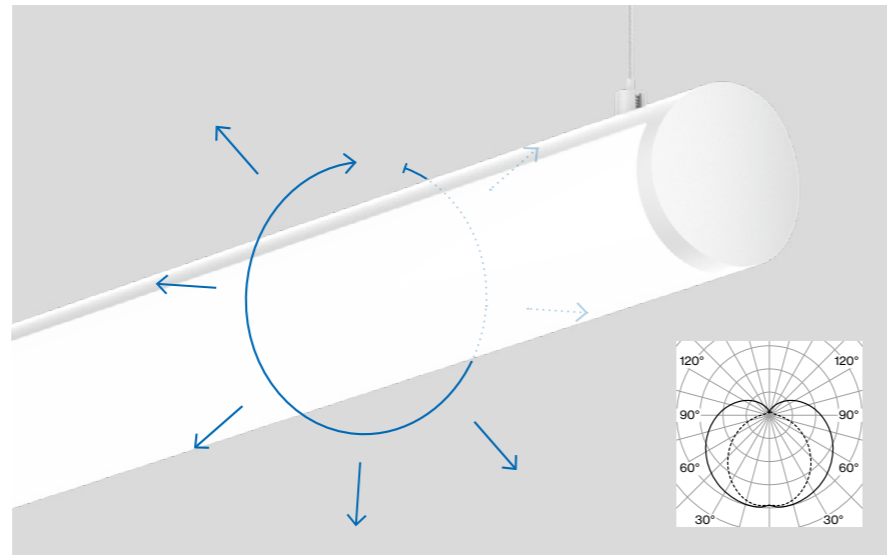

Work-friendly light

EN As an office luminaire, SETA guarantees illumination that is compliant with workplace standards (up to $UGR \leq 16$). Custom glare-free reflectors and the selected use of blind covers direct the light precisely to the work surface and reduce reflections. The direct/indirect version comes with special lens technology that distributes the indirect light component homogeneously and broadly towards the ceiling.

IT SETA in versione Office garantisce un'illuminazione a norma delle postazioni di lavoro (fino a $UGR \leq 16$). I riflettori opportunamente schermati si abbinano a shutter in modo da dirigere la luce con precisione sui piani di lavoro riducendo i riflessi. Nella variante diretta/indiretta, una speciale tecnologia di lenti distribuisce la luce indiretta a fascio molto largo e omogeneo sul soffitto.

Advanced sensor technology

EN Special sensors expand the product family SETA with smart lighting control and collection of insightful data. The ESSENTIAL sensor enables dynamic adjustment of the lighting to ambient brightness and room activity. The SENSE version also measures values such as temperature, air quality, humidity and noise level. These data not only provide important insights into the ambient conditions and use of rooms, but also support energy savings in the long term.

IT Per il controllo intelligente dell'illuminazione con la linea di prodotti SETA sono previsti sensori speciali. Il primo è il sensore ESSENTIAL, che consente la regolazione dinamica della luce in base alla luminosità circostante e all'attività svolta. La variante SENSE misura anche valori quali temperatura, qualità dell'aria, umidità e livello di rumore. Questi dati non solo forniscono importanti indicazioni sulle condizioni e sull'utilizzo degli ambienti, ma favoriscono anche il risparmio energetico a lungo termine.

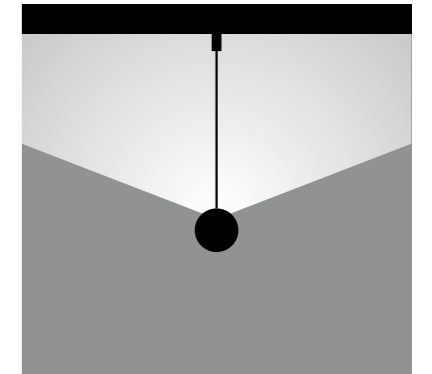
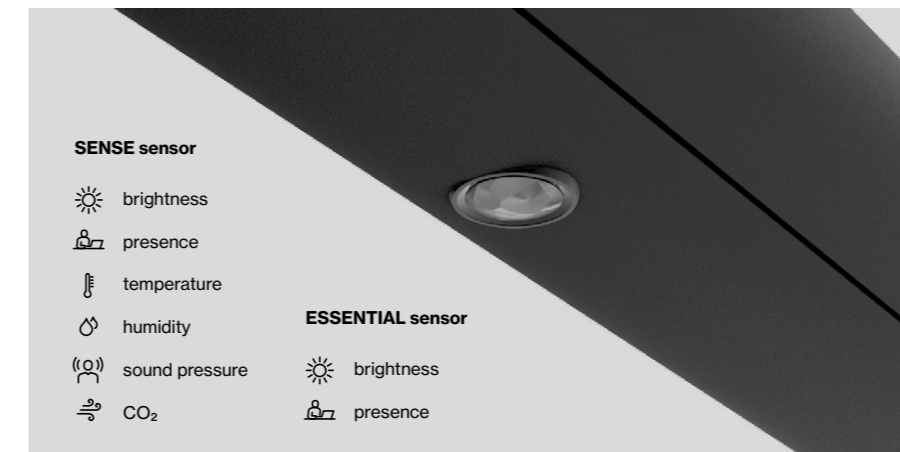

Indirect version

EN SETA indirect stands for the minimalist design of the product family and expands it with an indirect luminaire that provides homogeneous ceiling lighting. This creates a pleasant room feeling and the possibility to illuminate ceiling patterns harmoniously.

IT SETA indirect riprende il design minimalista della linea di prodotti integrandolo con una variante indiretta che diffonde una luminosità omogenea sul soffitto. Ne deriva una percezione gradevole degli spazi e anche la possibilità di valorizzare le architetture dei soffitti.

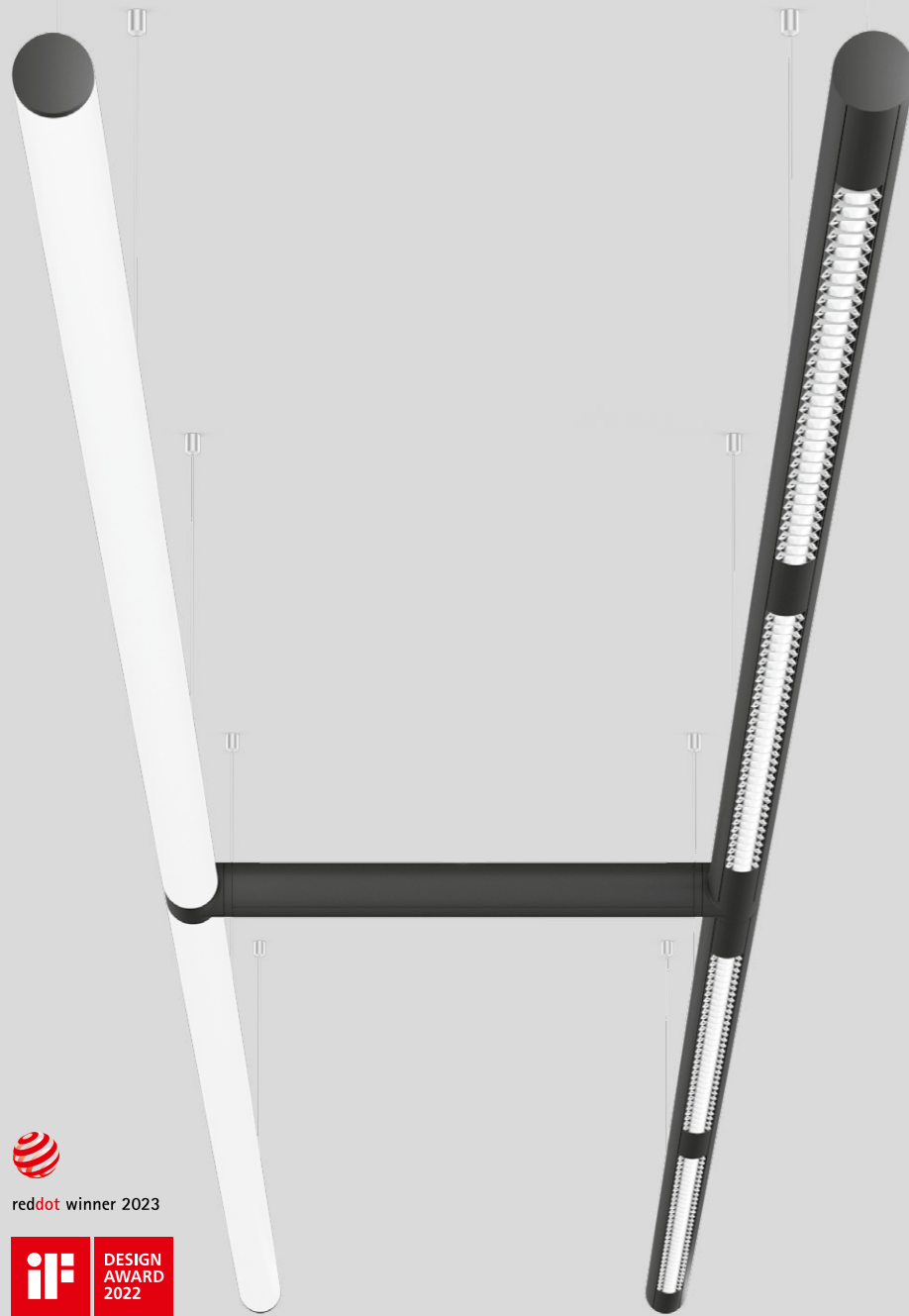

reddot winner 2023



TUBO/SETA 60 CONEX system

surface / suspended

EN Cylindrical lighting system in aluminium; powder coated; ceiling surface mounting or suspended mounting; height adjustment without tools; with transparent feeder cable; electrical connection of the luminaires via plug/socket system; optionally connectors (L-, T- or X-shape); luminaire connection rotatable around its own axis, which means that any spatial angle can be realized; optionally cylindrical HPO (High Performance Opal) cover or high gloss reflector with faceted design; light control via high quality lens system for homogeneous illumination (HPO); direct, indirect or direct / indirect light distribution (reflector); indirect light component with integrated PCBs and high quality lens system for homog. ceiling illumination, separately controllable; energy-eff. LEDs - very good colour rendering

IT Sistema di illuminazione cilindrico in alluminio; verniciatura a polvere; montaggio a soffitto o a sospensione; regolazione altezza senza utensili; con cavo di alimentazione trasparente; collegamento elettrico degli apparecchi tramite sistema presa/spina; connettore opzionale (a L, a T o a X); collegamento dell'apparecchio ruotabile attorno al proprio asse, il che rende possibile realizzare qualsiasi angolo spaziale; a scelta cover cilindrica HPO (High Performance Opal) o riflettore ad alta lucentezza con design sfaccettato; orientamento della luce controllabile tramite un'ottica lenticolare di alta qualità per un'illuminazione omogenea (HPO); emissione diretta, indiretta e diretta/indiretta (riflettore); componente luce indir. PCB speciali e ottica lent. di alta qualità per un'illuminazione omog. del soffitto, contr. separ.; LED a risp. energ. - ottima resa cromatica

Quickinfo

3000K, 4000K
CRI ≥ 80, 3 SDCM
UGR ≤ 19 / 65° ≤ 3000 cd/m²
opal up to 3230 lm/m
up to 160 lm/W
L90 @ 50 000h
DALI-2
opal, reflector (UGR ≤ 19)

Types

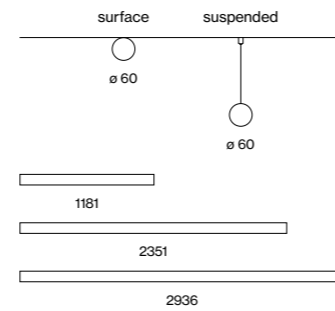

CONEX connector

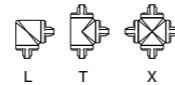

Colours

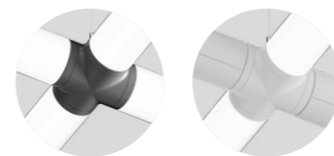
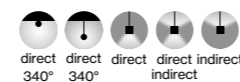
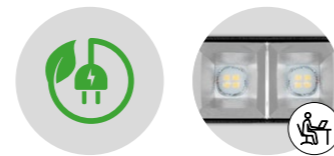
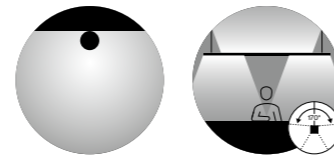

Light distributions

connector
CONEXcombinable with
TUBO & SETAup to 160 lm/W
(high efficiency)DIN EN 12464-1
UGR ≤ 19TUBO: direct
340° uniform
illuminationSETA: direct
and 170° indirect
illumination

Order options

THROUGH WIRE TYPE

standard	2
CONEX L/T/X	3

between two CONEX connectors
one CONEX luminaire or blind channel
is needed

COLOUR TEMPERATURE

3000K	5
4000K	6

CONTROL

DALI-2

MATERIAL COLOUR

○ pure white RAL 9010	7
● jet black RAL 9005	8

REFLECTOR COLOUR

✓ chrome	R
● dark chrome	B

TUBO 60 surface / suspended

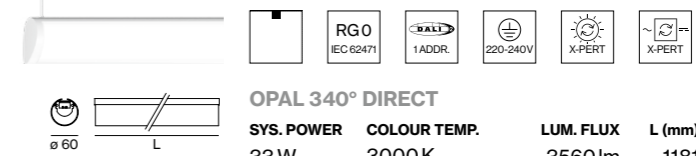

OPAL 340° DIRECT

SYS. POWER	COLOUR TEMP.	LUM. FLUX	L (mm)	ORDER CODE
33 W	3000K	3560lm	1181	058-30043
	4000K	3760lm		
66 W	3000K	7110lm	2351	058-30083
	4000K	7530lm		
82 W	3000K	8890lm	2936	058-30093
	4000K	9410lm		



SETA 60 surface / suspended

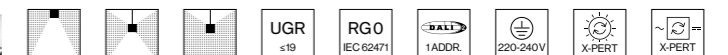

REFLECTOR DIRECT

SYS. POWER	COLOUR TEMP.	LUM. FLUX	L (mm)	ORDER CODE
19.3 W	3000K	2670lm	1181	058-40043
	4000K	3040lm		
45 W	3000K	6240lm	2351	058-40083
	4000K	7100lm		
58 W	3000K	8020lm	2936	058-40093
	4000K	9130lm		

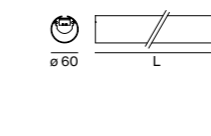

REFLECTOR DIRECT / INDIRECT

SYS. POWER	COLOUR TEMP.	LUM. FLUX	L (mm)	ORDER CODE
45 W	3000K	↓ 2670 / ± 3530lm	1181	058-41043
(2×DALI)	4000K	↓ 3040 / ± 4010lm		
92 W	3000K	↓ 6240 / ± 7050lm	2351	058-41083
(2×DALI)	4000K	↓ 7100 / ± 8030lm		
116 W	3000K	↓ 8020 / ± 8820lm	2936	058-41093
(2×DALI)	4000K	↓ 9130 / ± 10000lm		

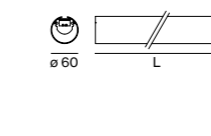

INDIRECT

SYS. POWER	COLOUR TEMP.	LUM. FLUX	L (mm)	ORDER CODE
26.1 W	3000K	3530lm	1181	058-42043
	4000K	4010lm		
52 W	3000K	7050lm	2351	058-42083
	4000K	8030lm		
65 W	3000K	8820lm	2936	058-42093
	4000K	10000lm		

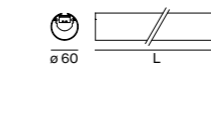

BLIND CHANNEL incl. through wiring

L (mm)	ORDER CODE
585	058-490203
1185	058-490403
2351	058-490803
2936	058-490903

Accessories

see next page

LUMINOUS FLUX value calculated for
CRI ≥ 80, colour white, cover opal
or reflector chrome

Configuration example

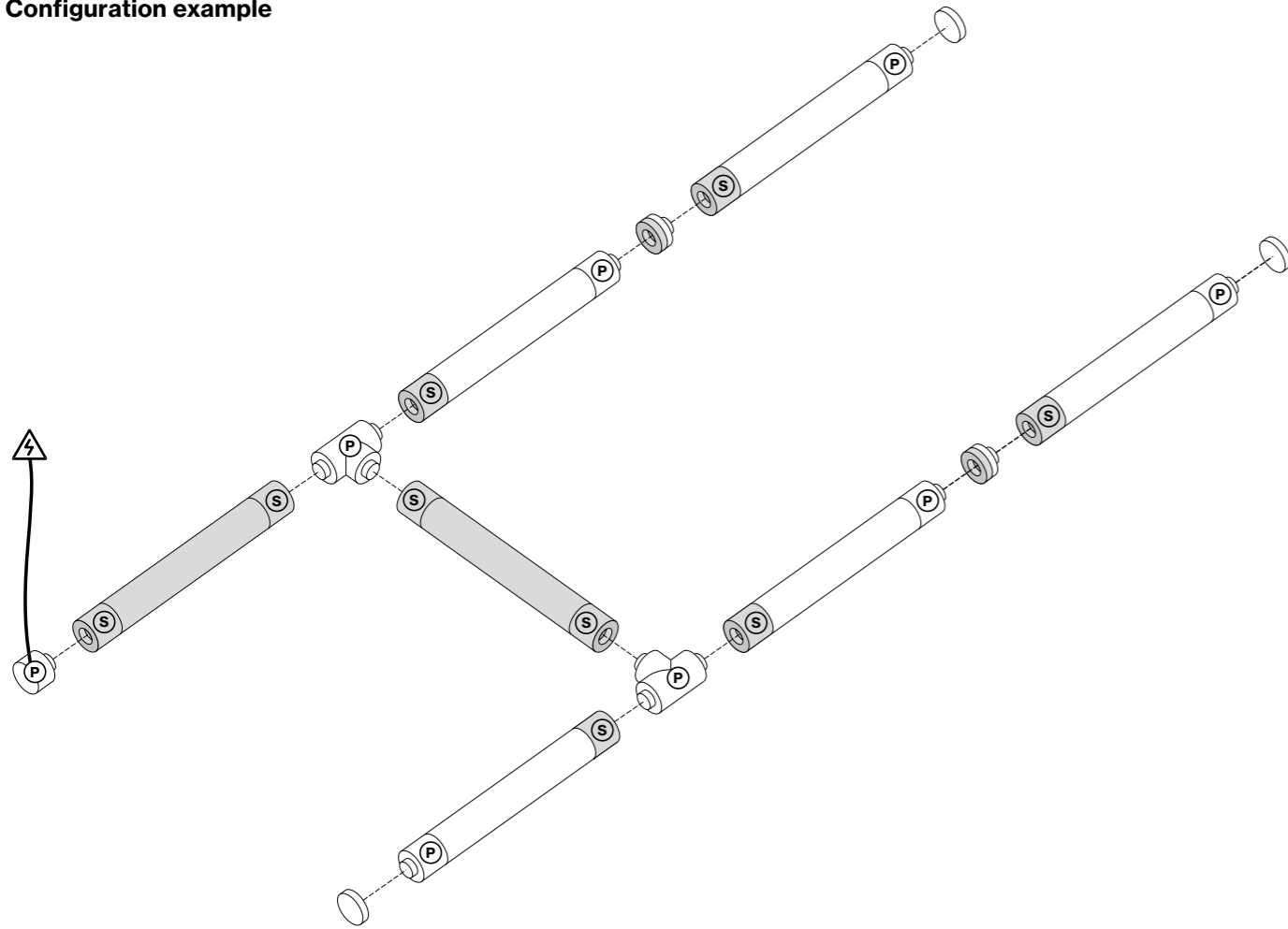

Components

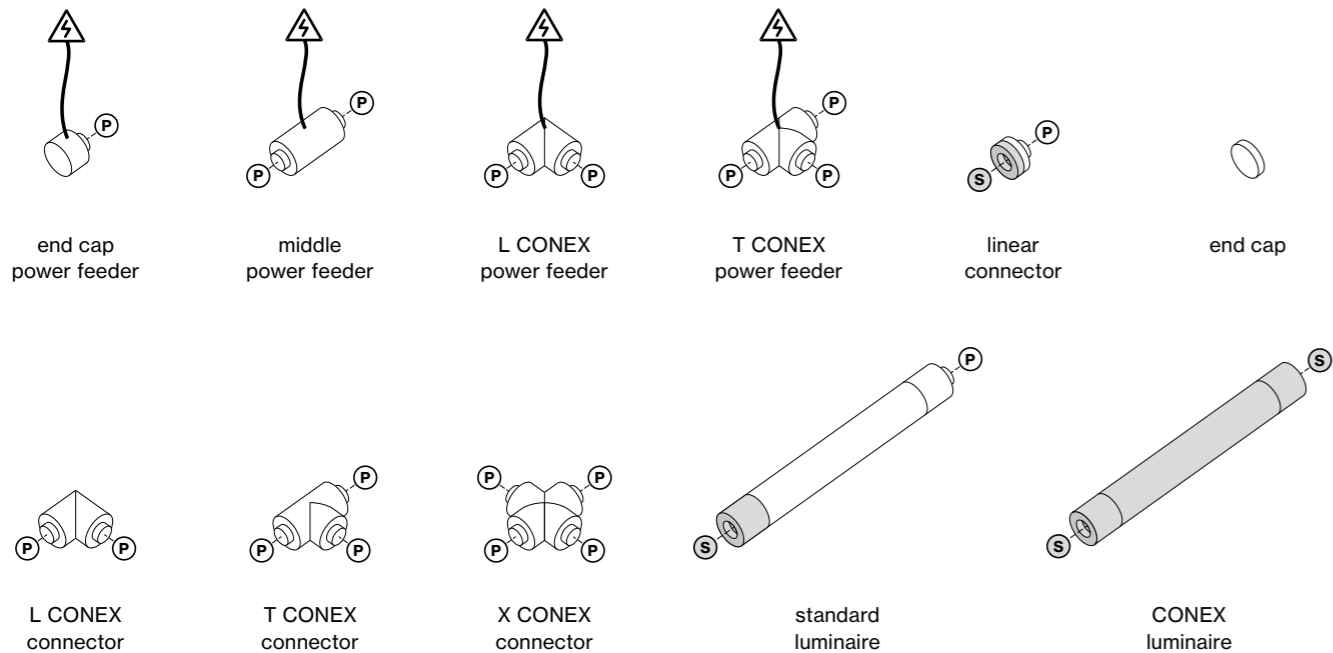

Order options

MATERIAL COLOUR	
○ pure white RAL 9010	7
● jet black RAL 9005	8

MATERIAL COLOUR	
CABLE SUSPENSION	
∕ chrome	0
● black	8

Accessories

END CAP		ORDER CODE
TYPE	end cap	058-301001

POWER FEEDER SURFACE		ORDER CODE
TYPE	end cap power feeder	058-301021
	middle power feeder*	058-301121

*incl. feeder cable 5 × 1.5 mm²

POWER FEEDER SUSPENDED		incl. feeder cable 5 × 1.5 mm ²	
TYPE	L (mm)	ORDER CODE	
end cap power feeder	1500	058-301041	
middle power feeder*	1500	058-301131	
L CONEX power feeder**	1500	058-301873	
T CONEX power feeder**	1500	058-301883	

*order cable suspension separately; **order CONEX cable suspension separately

LINEAR CONNECTOR		ORDER CODE
TYPE	linear connector mechanical	058-301311
	linear connector mechanical & electrical	058-301312

LINEAR CONNECTOR SUSPENDED		incl. cable suspension 1500 mm	
TYPE	L (mm)	ORDER CODE	
linear connector mechanical	1500	058-301321	
linear connector mech. & electr.	1500	058-301322	

CONEX CONNECTOR		ORDER CODE
TYPE	L CONEX connector mech. & electr.	058-301872
	T CONEX connector mech. & electr.	058-301882
	X CONEX connector mech. & electr.	058-301892

order CONEX cable suspension separately

MOUNTING SET		L (mm)	ORDER CODE
TYPE	ceiling mounting set	75	058-301411
	cable suspension	1500	058-301421
	cable suspension angular max. 60°	1500	058-301431
	CONEX cable suspension	1500	058-301811

CANOPY		ORDER CODE
TYPE	canopy	005-260003

for electrical system configuration see luminaire data sheet at xal.com

SENSOR DALI-2		ORDER CODE
TYPE	ESSENTIAL (brightness & presence)	058-301911
	SENSE (brightness, presence, temperature, sound pressure, humidity, CO ₂)	058-301921

XAL Headquarters Graz, AT

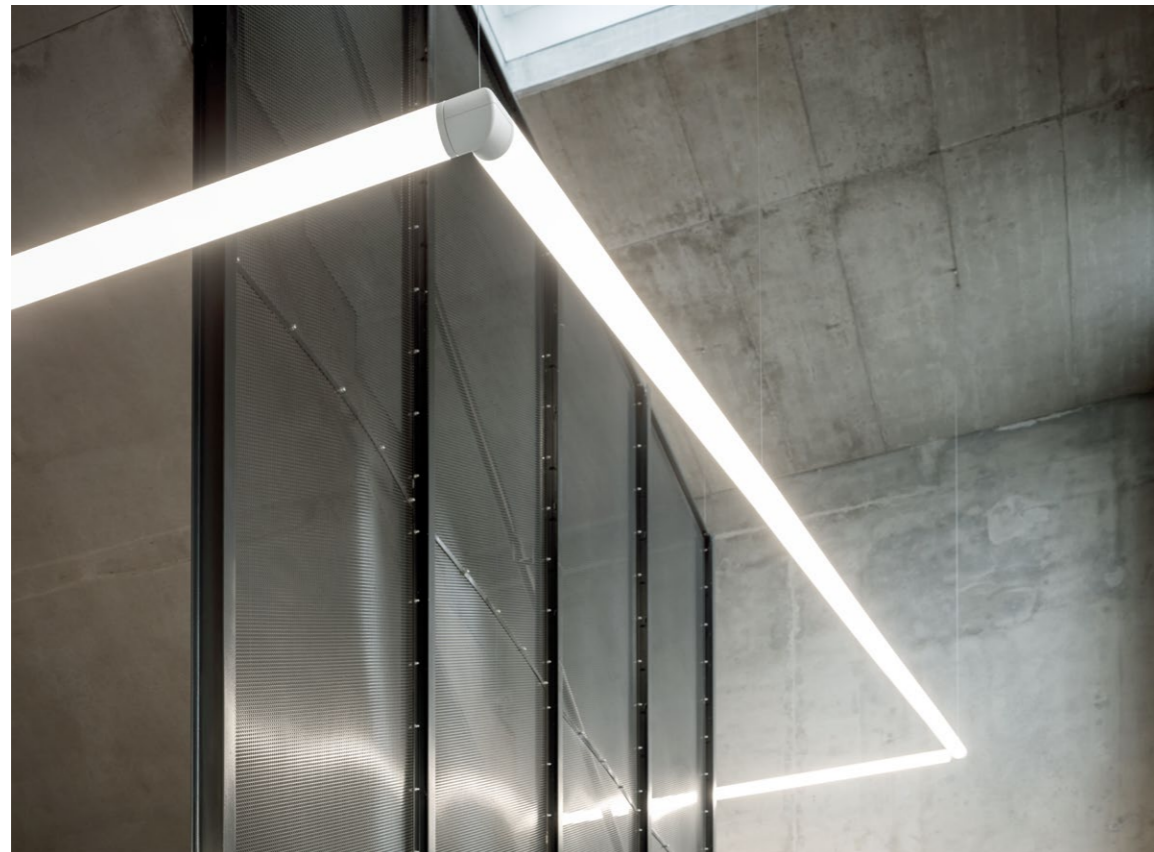
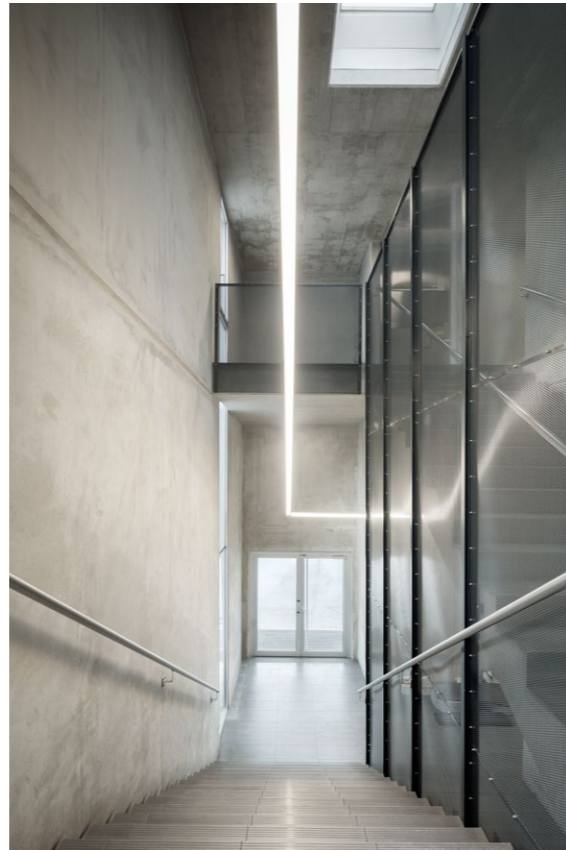

Discreet perfection



MITA

EN MITA combines high performance with a slim design language and its wide range of applications is impressive. The product family is available as recessed or surface-mounted luminaire in a round or square design as well as suspended version. All the versions of the luminaire have special reflectors for the best screen-compatible work lighting – perfect for use in offices or meeting rooms. The product family is available in the light colours 3000K, 4000K, or Tunable White. Optionally, the luminaire can be equipped with a presence and brightness sensor.

IT MITA è un apparecchio che unisce la potenza ad un linguaggio formale slanciato, prestandosi così a molte applicazioni. La linea di prodotti è prevista per montaggio a incasso, plafone o sospensione, in versione rotonda o quadrata. Tutti i modelli sono costruiti con riflettori speciali per lavorare al computer, ideali pertanto in uffici o sale riunioni. La serie è disponibile nelle temperature di colore 3000 K e 4000 K o come opzione Tunable White. Volendo si può integrare nell'apparecchio un sensore di presenza e luminosità.

Types

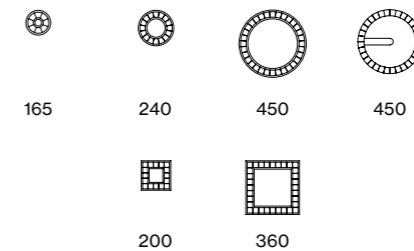

Mountings

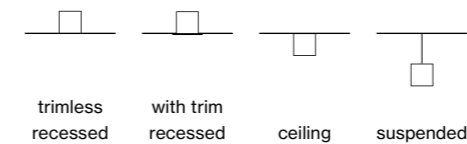

Light distributions

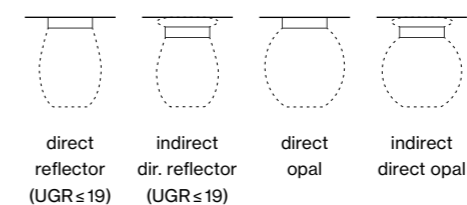



Variety

EN MITA is characterised by an elegant design language with maximum efficiency and versatile application possibilities. The MITA product family is available as a recessed or surface-mounted luminaire in round and square versions, as well as a suspended variant. For a uniform ceiling appearance, the cover can simply be attached magnetically and is available as a reflector or opal cover.

IT MITA vanta un linguaggio formale elegante e massima efficienza, ma convince anche per versatilità. La linea di prodotti è prevista per montaggio a incasso, plafone o sospensione, in versione rotonda o quadrata. Per mantenere unitario l'aspetto del soffitto si può fissare il riflettore con un semplice meccanismo magnetico, disponibile in variante a riflettore o con copertura opale.

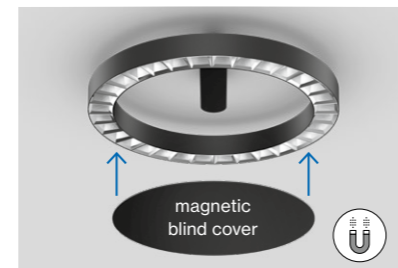



Advanced sensor technology

EN Special sensors expand the MITA product family with smart lighting control and collection of insightful data. The ESSENTIAL sensor enables dynamic adjustment of the lighting to ambient brightness and room activity. The SENSE sensor also measures values such as temperature, air quality, humidity and noise level. These data not only provide important insights into the ambient conditions and use of rooms, but also support energy savings in the long term.

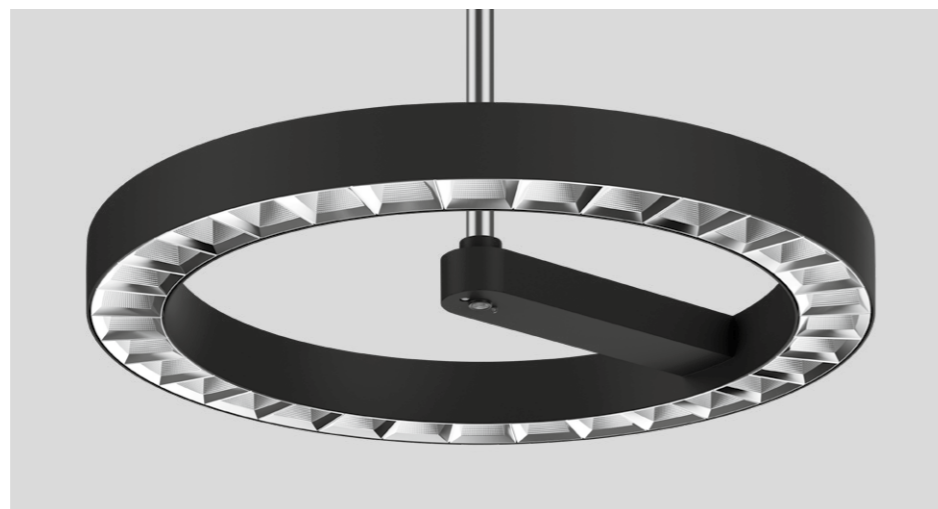





IT Per il controllo intelligente dell'illuminazione con la linea di prodotti MITA sono disponibili sensori speciali. Il primo è il sensore ESSENTIAL, che consente la regolazione dinamica dell'illuminazione in base alla luminosità circostante e all'attività svolta. La variante SENSE misura anche valori quali temperatura, qualità dell'aria, umidità e livello di rumore. Questi dati non solo forniscono importanti indicazioni sulle condizioni e sull'utilizzo degli ambienti, ma favoriscono anche il risparmio energetico a lungo termine.



ESSENTIAL sensor

-  brightness
-  presence

SENSE sensor

-  brightness
-  presence
-  temperature
-  humidity
-  sound pressure
-  CO₂

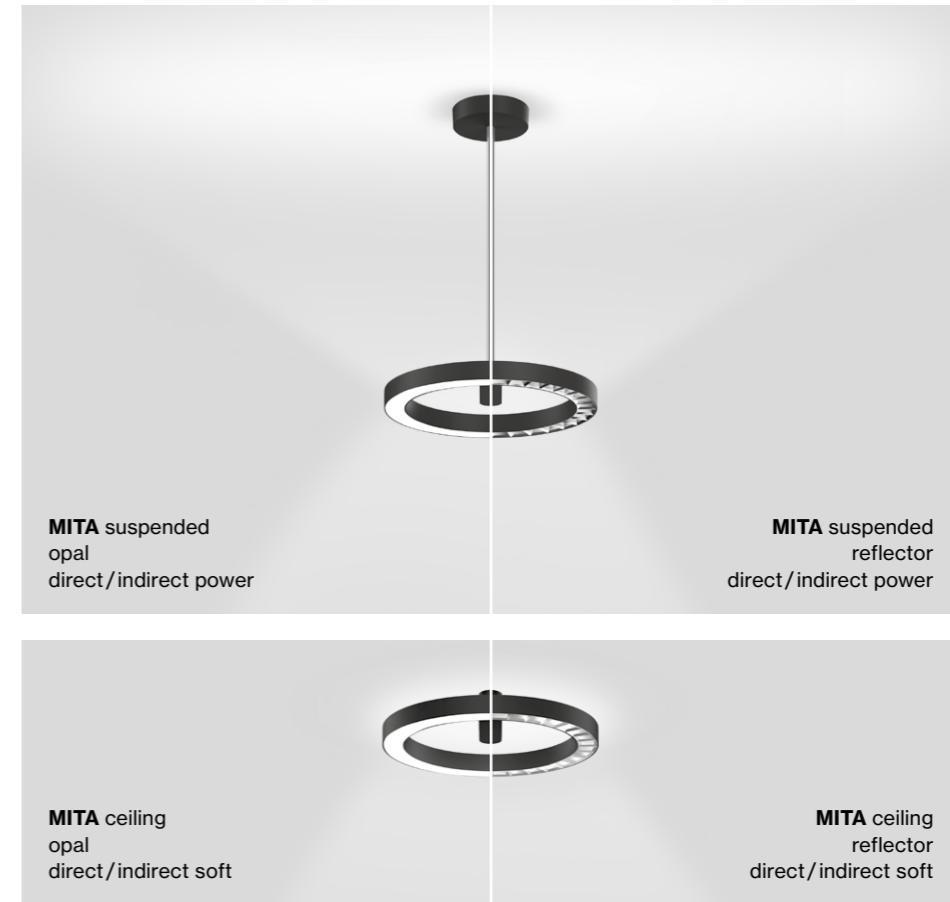

MITA suspended
opal
direct/indirect power

MITA suspended
reflector
direct/indirect power

MITA ceiling
opal
direct/indirect soft

MITA ceiling
reflector
direct/indirect soft

Light distribution

EN As an office luminaire, MITA guarantees the best possible working light. Special, glare-reduced reflectors direct the light precisely onto the work surface and reduce reflections. The opal cover ensures homogeneous room illumination. With the direct/indirect power version of the suspended luminaire, the indirect light component has a very wide beam and distributes the light evenly across the ceiling. The direct/indirect soft light component of the surface-mounted version produces a gentle and light ceiling illumination, making the luminaire appear to almost float.

IT MITA in versione Office garantisce un'illuminazione a norma delle postazioni di lavoro. I riflettori opportunamente schermati dirigono la luce con precisione sui piani di lavoro riducendo i riflessi. Nella variante diretta/indiretta dell'apparecchio a sospensione, la componente indiretta si distribuisce a fascio molto largo e omogeneo sul soffitto. La plafoniera a luce diretta/indiretta proietta invece una delicata luminosità sul soffitto, facendo sembrare l'apparecchio quasi fluttuante.



Discreet accentuation

EN MITA sets discreet accents for a pleasant room atmosphere. The product is available in black or white, and with or without a cover. The magnetic cover attaches easily and the indirect component provides gentle and light ceiling brightening.

IT MITA ceiling sa creare accenti garbati per un'atmosfera piacevole. È disponibile in bianco o nero, a scelta con riflettore. Quest'ultimo si fissa facilmente con un meccanismo magnetico. La componente indiretta crea una delicata luminosità sul soffitto, facendo sembrare l'apparecchio quasi fluttuante.

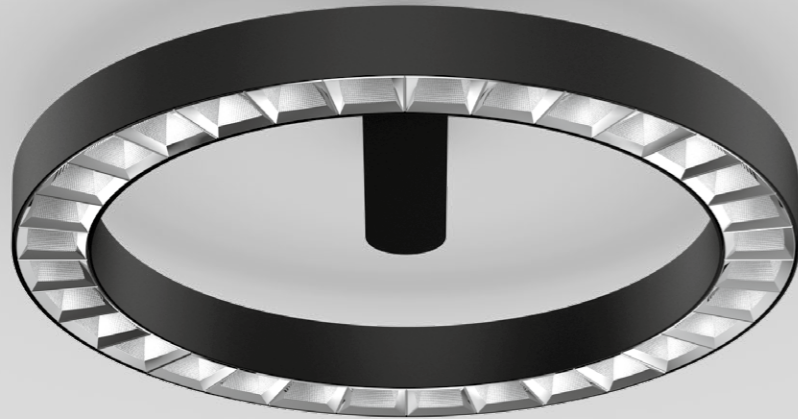

MITA circle

ceiling

EN Ring shaped luminaire housing in die-cast aluminium; extremely slim design; surface powder coated; luminaire housing set away from ceiling; electronic operating unit installed in the surface mounted housing; surface mounted housing aligned from the ring to the center; optional: blind cover to cover the cut-out, held by magnet, available as an accessory; high-gloss reflector with faceted design; HPO (High Performance Opal) cover for uniform illumination; either with direct or direct/indirect light distribution; energy-efficient LEDs with very good colour rendering

IT Corpo illuminante circolare in alluminio pressofuso; forma estremamente sottile; verniciatura a polvere; corpo distante dal soffitto; dispositivo di funz. elettr. nel housing a plafone; housing a plafone allineato dall'anello al centro; in opzione: copertura cieca, fissata nel vano interno per mezzo di un magnete, disponibile come accessorio; riflettore ad alta lucentezza con design sfaccettato; diffusore HPO (High Performance Opal) per un'illuminazione omogenea; a scelta con emissione diretta oppure diretta / indiretta; LED ad efficienza energetica con elevata resa cromatica

Quickinfo

3000K, 4000K
CRI ≥ 80, 3 SDCM
UGR ≤ 19 / 65° ≤ 1500 cd/m²
up to 158 lm/W
L90 @ 50 000h
DALI-2, DALI-2 sensor
reflector (UGR ≤ 19), opal

Types

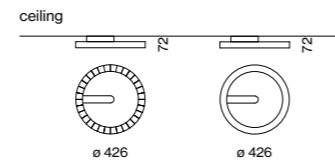

Colours



Light distributions

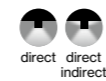

dark chrome
reflector option



up to 158 lm/W
(high efficiency)

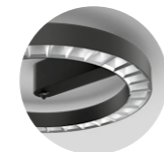

sensor version
available



version with
opal cover



magnetic
blind cover



DIN EN 12464-1
UGR ≤ 19

Order options

COLOUR TEMPERATURE	
3000K	5
4000K	6

CONTROL	
DALI-2	3
DALI-2 ESSENTIAL sensor (brightness & presence)	B
DALI-2 SENSE sensor (brightness, presence, temp., sound pressure, humidity, CO ₂)	P

MATERIAL COLOUR	
○ traffic white RAL 9016	7
● jet black RAL 9005	8

REFLECTOR COLOUR	
◊ chrome	R
● dark chrome	B

LIGHT OPTIC COVER	
reflector (UGR ≤ 19)	
opal	

Options on request

COLOUR RENDERING INDEX	
CRI ≥ 90	

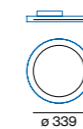
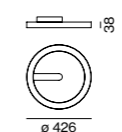
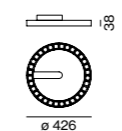
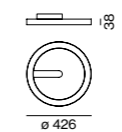
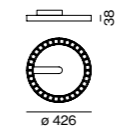

MITA circle 450 ceiling



REFLECTOR DIRECT

SYSTEM POWER	COLOUR TEMP.	LUMINOUS FLUX	ORDER CODE
30W	3000K	4210 lm	074-75111
	4000K	4790 lm	
40W	3000K	5470 lm	074-75211
	4000K	6230 lm	

OPAL DIRECT

SYSTEM POWER	COLOUR TEMP.	LUMINOUS FLUX	ORDER CODE
24.9W	3000K	2770 lm	074-75111
	4000K	3150 lm	



REFLECTOR DIRECT / INDIRECT SOFT

SYSTEM POWER	COLOUR TEMP.	LUMINOUS FLUX	ORDER CODE
30W	3000K	↓ 4220 / ↑ 722 lm	074-75311
	4000K	↓ 4800 / ↑ 822 lm	
40W	3000K	↓ 5490 / ↑ 942 lm	074-75611
	4000K	↓ 6240 / ↑ 1072 lm	

OPAL DIRECT / INDIRECT SOFT

SYSTEM POWER	COLOUR TEMP.	LUMINOUS FLUX	ORDER CODE
24.9W	3000K	↓ 2700 / ↑ 136 lm	074-75311
	4000K	↓ 3080 / ↑ 155 lm	

Accessories

BLIND COVER

TYPE	ORDER CODE
MITA circle 450 ceiling	074-891162
MITA circle 450 ceiling sensor	074-891163

Light distribution

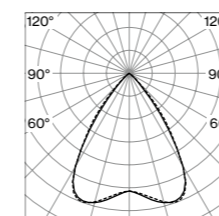

reflector (UGR ≤ 19)
direct

LUMINOUS FLUX value calculated for
CRI ≥ 80, colour white, reflector chrome

Meeting room
Visualisation



Hallway
Visualisation





MITA circle

suspended

EN Ring shaped luminaire housing in die-cast aluminium; extremely slim design; surface powder coated; suspended; with height adjustable rod suspension (chrome), feed in rod; electronic operating unit installed in the canopy; optional: blind cover to cover the cut-out, held by magnet, available as an accessory; high gloss reflector with faceted design; HPO (High Performance Opal) cover for uniform illumination; either with direct or indirect light distribution; energy-efficient LEDs with very good colour rendering

IT Corpo illuminante circolare in alluminio pressofuso; forma estremamente sottile; verniciatura a polvere; sospeso; con asta di sospensione accorciabile (cromata), cavo alimentazione nell'asta di sospensione; alimentatore elettronico montato nel rosone; in opzione: copertura cieca, fissata nel vano interno per mezzo di un magnete, disponibile come accessorio; riflettore ad alta lucentezza con design sfaccettato; diffusore HPO (High Performance Opal) per un'illuminazione omogenea; a scelta con emissione diretta oppure diretta/indiretta; LED ad efficienza energetica con elevata resa cromatica

Quickinfo

3000K, 4000K
CRI ≥ 80, 3 SDCM
UGR ≤ 19 / 65° ≤ 1500 cd/m²
up to 160 lm/W
L90 @ 50 000 h
DALI-2, DALI-2 sensor
reflector (UGR ≤ 19), opal

Types

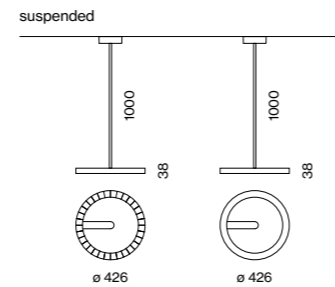

Colours



Light distributions

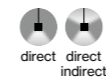

dark chrome
reflector option



up to 160 lm/W
(high efficiency)

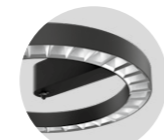

sensor version
available



version with
opal cover



magnetic
blind cover



DIN EN 12464-1
UGR ≤ 19

Order options

SUSPENSION
rod 1000 mm

COLOUR TEMPERATURE

3000K	5
4000K	6

CONTROL

DALI-2	3
DALI-2 ESSENTIAL sensor (brightness & presence)	B
DALI-2 SENSE sensor (brightness, presence, temp., sound pressure, humidity, CO ₂)	P

MATERIAL COLOUR

○ traffic white RAL 9016	7
● jet black RAL 9005	8

REFLECTOR COLOUR

▨ chrome	R
● dark chrome	B

LIGHT OPTIC COVER
reflector (UGR ≤ 19)
opal

Options on request

SUSPENSION
rod 1000 mm white
rod 1000 mm black

COLOUR RENDERING INDEX
CRI ≥ 90

COLOUR TEMPERATURE
tunable white 2700–6500 K

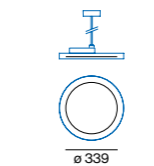
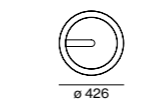
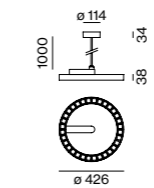
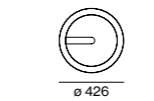
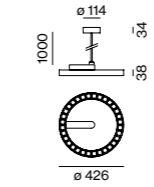

MITA circle 450 suspended



REFLECTOR DIRECT

SYSTEM POWER	COLOUR TEMP.	LUMINOUS FLUX	ORDER CODE
30W	3000K	4210 lm	074-76111
41W	3000K	5470 lm	074-76211
	4000K	4790 lm	
	4000K	6230 lm	

OPAL DIRECT

SYSTEM POWER	COLOUR TEMP.	LUMINOUS FLUX	ORDER CODE
25.1W	3000K	2770 lm	074-76111
	4000K	3060 lm	



REFLECTOR DIRECT / INDIRECT POWER

SYSTEM POWER	COLOUR TEMP.	LUMINOUS FLUX	ORDER CODE
58W	3000K	↓ 4030 / ↑ 3780 lm	074-76511
	4000K	↓ 4600 / ↑ 4310 lm	

OPAL DIRECT / INDIRECT POWER

SYSTEM POWER	COLOUR TEMP.	LUMINOUS FLUX	ORDER CODE
58W	3000K	↓ 3140 / ↑ 3780 lm	074-76511
	4000K	↓ 3570 / ↑ 4310 lm	

Accessories

BLIND COVER

TYPE	ORDER CODE
MITA circle 450 suspended	074-891162
MITA circle 450 suspended sensor	074-891163

LUMINOUS FLUX value calculated for
CRI ≥ 80, colour white, reflector chrome

ALLPLAN Österreich GmbH
Graz, AT



Hidden talent



SPIO

EN Round, recessed SPIO spotlights bring special lighting to your rooms. The luminaire provides an impressive lighting effect, trimless or with a trim. The housing can be painted over, allowing the spotlight to blend seamlessly into the ceiling. The small light aperture of 10 mm makes the SPIO itself appear almost hidden – but the equally effective and calm overall impression is anything but invisible. The round, recessed spotlight is available with beam angles of 35° or 44° and can be rotated 360° in the housing and pivoted 30° in all directions. In addition, SPIO 20 is available with Wallwasher Floor optic, which creates an uniform wall illumination. These different lighting options mean that versatile designs for interiors are possible. SPIO is available in the light colours 2700 K, 3000 K, and 4000 K.

IT I faretto rotondi da incasso SPIO portano nell'ambiente un'illuminazione particolare. Costruiti con o senza cornice, generano comunque un effetto di luce molto interessante. L'armatura può essere semplicemente tinteggiata: in questo modo il faretto si fonde alla perfezione con la superficie. La stessa apertura di emissione, di soli 10 mm, sembra tenere il faretto SPIO quasi nascosto. Tuttavia l'effetto generale, suggestivo e riposante, è tutt'altro che invisibile. Lo spot rotondo è previsto con angolo di emissione di 34° o 44°. L'elemento si ruota di 360° e si orienta di 30° in tutte le direzioni. Per SPIO 20 è disponibile anche un'ottica Wallwasher Floor che assicura una luminosità uniforme sulle pareti. Con questo sistema si diversifica la composizione di luce. SPIO è disponibile nelle temperature di colore 2700 K, 3000 K e 4000 K.

Types

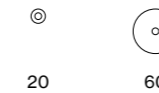

20

60

Mountings

trimless
recessedwith trim
recessed

Light distributions

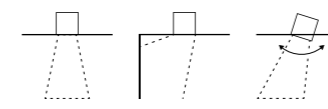

downlight

floor
wallwasher

spotlight

High-efficiency lens

EN Large light output – almost unnoticed. SPIO has a special LFO lens, which is mounted at an exact distance from the light-emission surface, thus ensuring that no light beam appears on the inner surface of the housing. This reduces the light-emission surface, and SPIO illuminates the room almost unnoticed.

IT Luce di grande efficacia ma quasi impercettibile. SPIO è costruito con lenti speciali LFO, montate a una distanza precisa dalla superficie di emissione della luce. Questa distanza è calcolata in modo tale che le radiazioni luminose non incidano sulla parte interna. In altre parole la superficie di emissione si riduce e i faretti SPIO illuminano senza farsi notare.

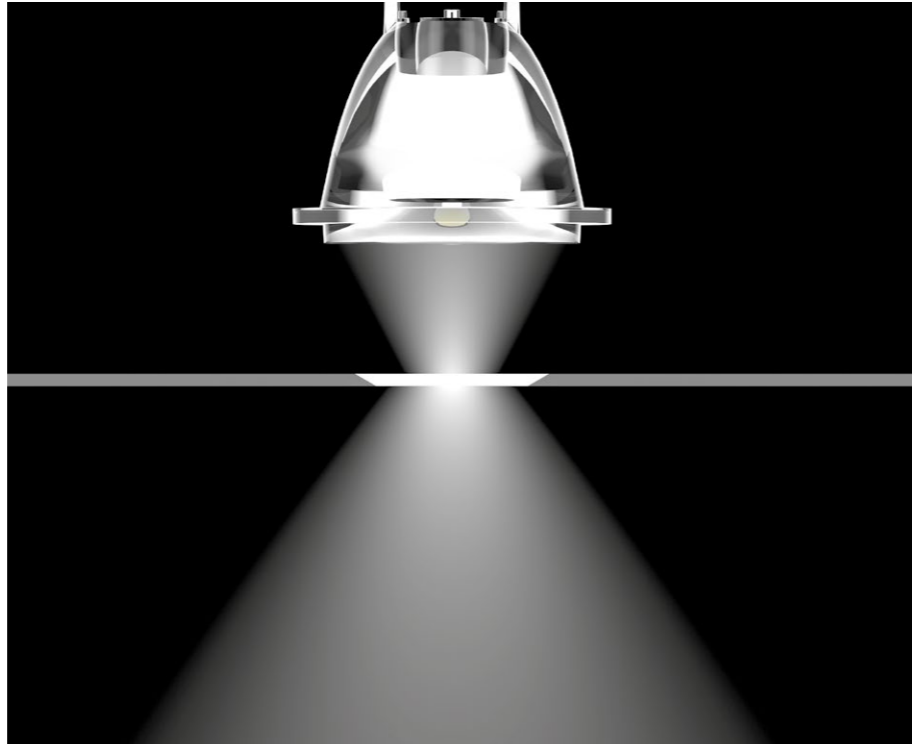

Light distribution

EN Despite its small emission surface, the recessed spotlight achieves a beam angle of either 35° or 44°. SPIO 20 is also available with Wallwasher Floor optic, which creates a homogeneous wall brightening effect. SPIO thus provides glare-free light and skilfully stages objects.

IT A dispetto della superficie di emissione ridotta, il faretto SPIO distribuisce la luce con un angolo di 34° o 44° a scelta. Per SPIO 20 è prevista anche un'ottica Wallwasher Floor che assicura una luminosità omogenea sulle pareti. Ne deriva un'illuminazione che non abbaglia e che mette gli oggetti abilmente in scena.

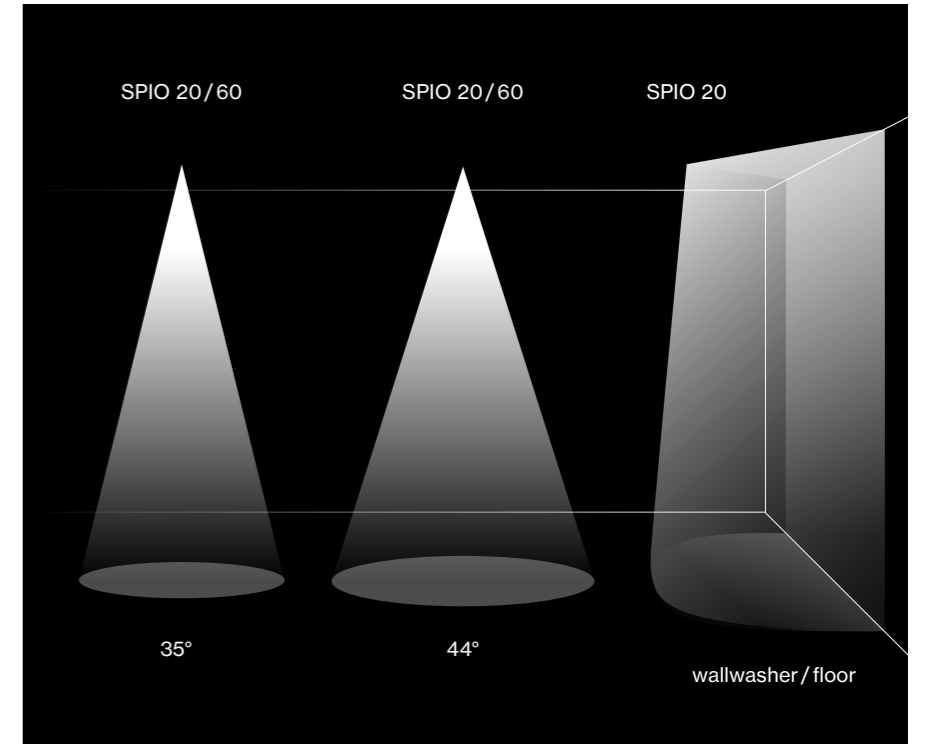

Homogeneous appearance

EN SPIO is the right choice for a uniform ceiling appearance. Thanks to its extremely small light aperture of 10 mm, the recessed spotlight appears almost invisible. The effective lighting is rounded off by its minimalist design language.

IT SPIO costituisce la scelta migliore per un soffitto di aspetto unitario. Con la sua apertura di emissione decisamente ridotta, di soli 10 mm, il faretto incassato sembra quasi invisibile. Il particolare effetto di luce è sottolineato dal minimalismo del linguaggio formale.

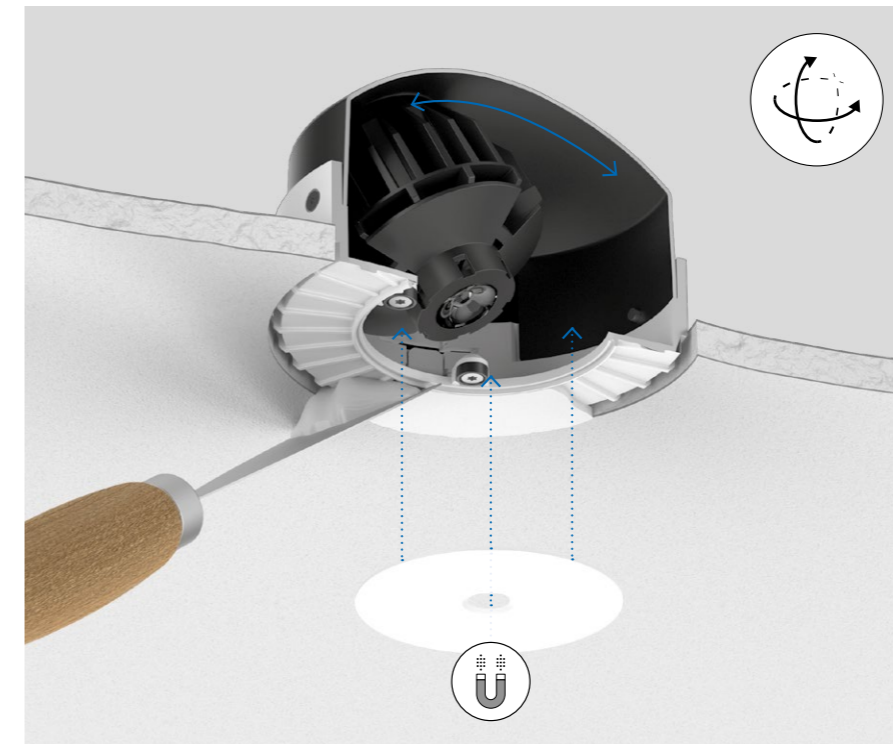

Precise light adjustment

EN The adjustable version of SPIO 60, patent pending, can be moved in all directions thanks to a magnetic plate. The spotlight can thus both be rotated 360° and pivoted up to 30° in all directions. As a result, it offers the greatest flexibility in directing and guiding light exactly where it is desired.

IT SPIO 60 in versione adjustable, per la quale è stato richiesto il brevetto, si muove in tutte le direzioni con una testata magnetica. Pertanto il faretto non si limita a ruotare di 360° ma si inclina fino a 30° in ogni direzione. Ne deriva un'assoluta flessibilità nel guidare la luce esattamente dov'è richiesto.

Smooth and invisible

EN The trimless SPIO 60 version can easily be maintained and adjusted thanks to its magnetic cover. The spotlight is completely fitted into a plasterboard ceiling. The recessed housing and ceiling can subsequently be painted over. The spots thus appear "invisible", creating a homogeneous, effective overall impression.

IT La variante SPIO 60 senza bordi si regola con facilità grazie alla sua copertura magnetica. Il faretto si incassa interamente in un soffitto di cartongesso. In seguito l'alloggiamento può essere tinteggiato insieme al soffitto. In questo modo gli spot diventano "invisibili", creando un aspetto d'insieme omogeneo e suggestivo.

SPIO 20

recessed

EN Round recessed spotlight in die-cast aluminium; installation without tools in mounting set with ball catch system or using snap spring closure; special mounting tool for easy installation of the trimless housing available as an accessory; for trimless installation in plasterboard ceilings; paintable light inset; shadow joint between light inset and mounting set optionally fillable; or with trim; with optional high quality lens system with precise radiation characteristic; or high quality, aluminium, vapour deposition coated reflector with faceted design; precise radiation characteristics with different beam angles; uncluttered ceiling look through recessed lighting level; reduced light-emitting surface - only $\varnothing 10$ mm (DOWNLIGHT) or $\varnothing 13$ mm (WALLWASHER/FLOOR); no multiple shadows; energy-eff. LEDs - very good colour rendering

IT Faretto da incasso rotondo in alluminio pressofuso; montaggio senza attrezzi con il set di montaggio con moschettone sferico o con chiusura a molla a scatto; utensile di montaggio speciale per una facile installazione dell'housing senza bordi disponibile come accessorio; incasso a scomparsa in soffitti di cartongesso; unità luminosa verniciabile; giunto nascosto tra l'insero luminoso e il set di montaggio stuccabile a scelta; o con bordo perimetrale; a scelta con ottica lenticolare di precisione; oppure riflettore d'alta qualità con ottica sfaccettata in alluminio applicato a vapore; curva fotometrica precisa con diversi angoli di emissione; superficie di emissione arretrata per un soffitto di aspetto armonioso; superficie di emissione della luce ridotta: solo $\varnothing 10$ mm (DOWNLIGHT) o $\varnothing 13$ mm (WALLWASHER/FLOOR); assenza di ombre multiple; LED a risp. energ. - ottima resa cromatica

Quickinfo

2700 K, 3000 K
CRI ≥ 90 , 3 SDCM
up to 70 lm/W
L95 @ 50 000 h
non DIM, DALI-2

Types

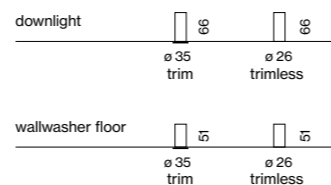

Colours



Light distributions

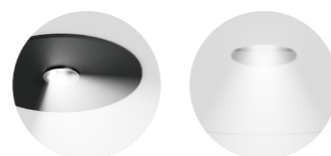

version with trim available

10 mm light output area

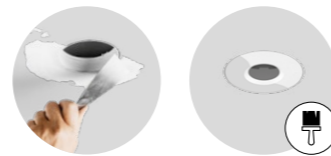

trimless installation

paintable cover

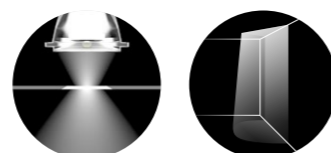

LFO lens technology

wallwasher floor

Order options

COLOUR TEMPERATURE	☐☐
2700 K	4
3000 K	5

MATERIAL COLOUR	☑
○ traffic white RAL 9016	7
● jet black RAL 9005	8

REFLECTOR COLOUR	
● jet black RAL 9005	
paintable cover	

BEAM ANGLE	▲
flood 35°	F
wide flood 44°	W

Options on request

COLOUR RENDERING INDEX	
CRI ≥ 95 , 2 SDCM	

COLOUR TEMPERATURE	
4000 K	

CONCRETE HOUSING	
primed concrete ceiling	
exposed concrete ceiling	

REFLECTOR COLOUR	
○ traffic white* RAL9016	
*only for wallwasher / floor	



SPIO 20 downlight



DOWNLIGHT TRIMLESS

INSET POWER	LUMINOUS FLUX	ORDER CODE
6.5 W 12 Vf 600 mA	435 lm	0 4 8 - 1 7 1 0 :: 1 0 ▲

TRIMLESS MOUNTING SET for plasterboard ceilings 9–25 mm

COLOUR	ORDER CODE
○ traffic white RAL9016	0 4 8 - 1 6 9 8 1 0 7

DOWNLIGHT TRIM

INSET POWER	LUMINOUS FLUX	ORDER CODE
6.5 W 12 Vf 600 mA	435 lm	0 4 8 - 1 6 1 0 :: 1 1 ▲

SPIO 20 wallwasher / floor



WALLWASHER/FLOOR TRIMLESS

INSET POWER	LUMINOUS FLUX	ORDER CODE
5.9 W 5.6 Vf 1050 mA	414 lm	0 4 8 - 1 7 3 0 :: 1 0 8 W

TRIMLESS MOUNTING SET for plasterboard ceilings 9–25 mm

COLOUR	ORDER CODE
○ traffic white RAL9016	0 4 8 - 1 6 9 8 1 0 7

WALLWASHER/FLOOR TRIM

INSET POWER	LUMINOUS FLUX	ORDER CODE
5.9 W 5.6 Vf 1050 mA	414 lm	0 4 8 - 1 6 3 0 :: 1 1 8 W

Mounting accessories

SPECIAL MOUNTING TOOL

TYPE	Ø-H (mm)	ORDER CODE
SPIO 20	73-107	0 4 8 - 1 6 9 0 0 0 0

necessary to install mounting housing trimless

Electrical accessories

POWER SUPPLY 220-240 V AC, 50-60 Hz, PC II

TYPE	EFFICIENCY	L-W-H (mm)	ORDER CODE
600 mA max. 43 V non DIM	η 85 %	147-44-22	0 0 2 - 9 0 7 8 3
600 mA max. 46 V DALI-2	η 85 %	143-43-30	0 0 2 - 9 0 7 8 4
1050 mA max. 25 V non DIM	η 85 %	111-38-28	0 0 2 - 9 0 7 8 7
1050 mA max. 42 V DALI-2	η 85 %	143-43-30	0 0 2 - 9 0 7 8 8

revision opening required

DIN RAIL COMPONENTS

TYPE	W-H-D (mm)	ORDER CODE
POWER SUPPLY 220-240 V AC	72-90-63	0 0 5 - 6 5 2 0 2 1 0
160 W 48 V DC constant voltage		
LED DRIVER DALI-2 DT6 1-2 addr.	36-88-59	0 0 5 - 6 1 2 1 0 3 0
200-1050 mA settable const. current		
2 x 42 W 48 V DC U _{OUT} 10-40 V		

for more details and components see XAL 22 catalog, page 980

INSET POWER is the current consumption excluding any ballast
LUMINOUS FLUX value calculated for 3000 K, CRI ≥ 90 , colour white, lens wide flood, 2700 K -3 %

Private Residence
Visualisation



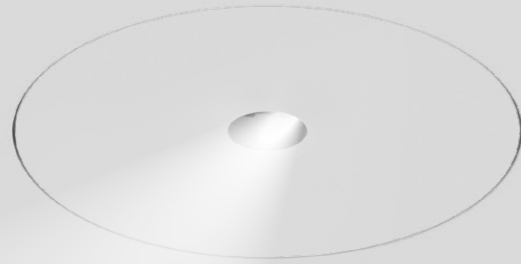

reddot winner 2022



DESIGN
AWARD
2022

SPIO 60

recessed

EN Round recessed spotlight in die-cast aluminium; installation without tools in mounting set with ball catch system or with magnetic attachment; for trimless installation in plasterboard ceilings; paintable cover; shadow joint between cover and mounting set optionally fillable; or with trim; choice of adjustable or fixed symmetric radiation characteristic; high quality lens system; uncluttered ceiling look through recessed lighting level; reduced light-emitting surface (only $\varnothing 10$ mm); no multiple shadows; efficient LEDs with very good colour rendering

IT Faretto da incasso rotondo in alluminio pressofuso; set di fissaggio con cuscinetto a sfera, senza bisogno di utensili o con attacco magnetico; incasso a scomparsa in soffitti di cartongesso; piastra verniciabile; giunto nascosto tra la piastra e il set di montaggio stuccabile a scelta; o con bordo perimetrale; emissione a scelta regolabile o fissa simmetrica; ottica lenticolare di qualità; superficie di emissione arretrata per un soffitto di aspetto armonioso; superficie di emiss. ridotta (solo $\varnothing 10$ mm); assenza di ombre multiple; LED efficienti con alta resa cromatica

Quickinfo

2700 K, 3000 K
CRI ≥ 90 , 3 SDCM
up to 60 lm/W
L95 @ 50 000 h
non DIM, DALI-2

Types

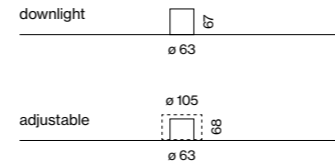

Colours



Light distributions



version with
trim available



10 mm light
output area



trimless
installation

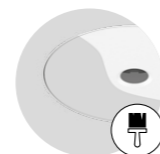

paintable
cover

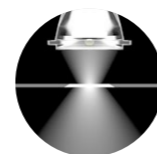

LFO lens
technology

Order options

COLOUR TEMPERATURE	
2700 K	4
3000 K	5

MATERIAL COLOUR

traffic white RAL9016

paintable cover

BEAM ANGLE

flood 35°	F
wide flood 44°	W

Options on request

COLOUR TEMPERATURE

4000 K

CONCRETE HOUSING

primed concrete ceiling
exposed concrete ceiling

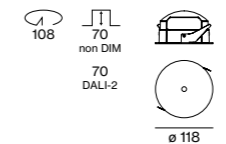
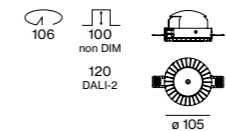
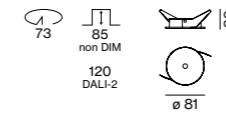
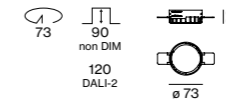
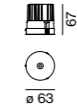

SPIO 60 downlight

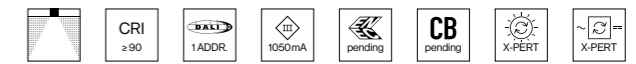

DOWNLIGHT

INSET POWER	LUMINOUS FLUX	ORDER CODE
11.9W 12Vf 1050mA	718lm	048-1510::17▲

Mounting accessories

TRIMLESS MOUNTING SET for plasterboard ceilings 12.5/15/25 mm

COLOUR	ORDER CODE
<input type="radio"/> traffic white RAL9016	048-2696117

MOUNTING SET WITH TRIM for intermediate ceilings 2-25 mm

COLOUR	ORDER CODE
<input type="radio"/> traffic white RAL9016	048-1597207
<input checked="" type="radio"/> jet black RAL 9005	048-1597208

SPIO 60 adjustable



ADJUSTABLE

INSET POWER	LUMINOUS FLUX	ORDER CODE
11.9W 12Vf 1050mA	685lm	048-1520::17▲

Mounting accessories

TRIMLESS MOUNTING SET for plasterboard ceilings 12.5/15/25 mm

COLOUR	ORDER CODE
<input type="radio"/> traffic white RAL9016	048-1598107

MOUNTING SET WITH TRIM for intermediate ceilings 2-25 mm

COLOUR	ORDER CODE
<input type="radio"/> traffic white RAL9016	048-1597107
<input checked="" type="radio"/> jet black RAL 9005	048-1597108

Electrical accessories

POWER SUPPLY 220-240 V AC, 50-60 Hz, PC II

TYPE	EFFICIENCY	L-W-H (mm)	ORDER CODE
1050 mA non DIM	η 85 %	111-38-28	002-90787
1050 mA DALI-2	η 85 %	143-43-30	002-90788

DIN RAIL COMPONENTS

TYPE	W-H-D (mm)	ORDER CODE
POWER SUPPLY 220-240 V AC	72-90-63	005-6520210
160W 48V DC constant voltage		
LED DRIVER DALI-2 DT6 1-2 addr.	36-88-59	005-6121030
200-1050 mA settable const. current		
2 x 42W 48V DC U _{OUT} 10-40V		

for more details and components see XAL 22 catalog, page 980

INSET POWER is the current consumption excluding any ballast
LUMINOUS FLUX value calculated for 3000 K, CRI ≥ 90 , colour white, lens wide flood, 2700 K -5%

Private Residence
Visualisation



High-precision shelf lighting

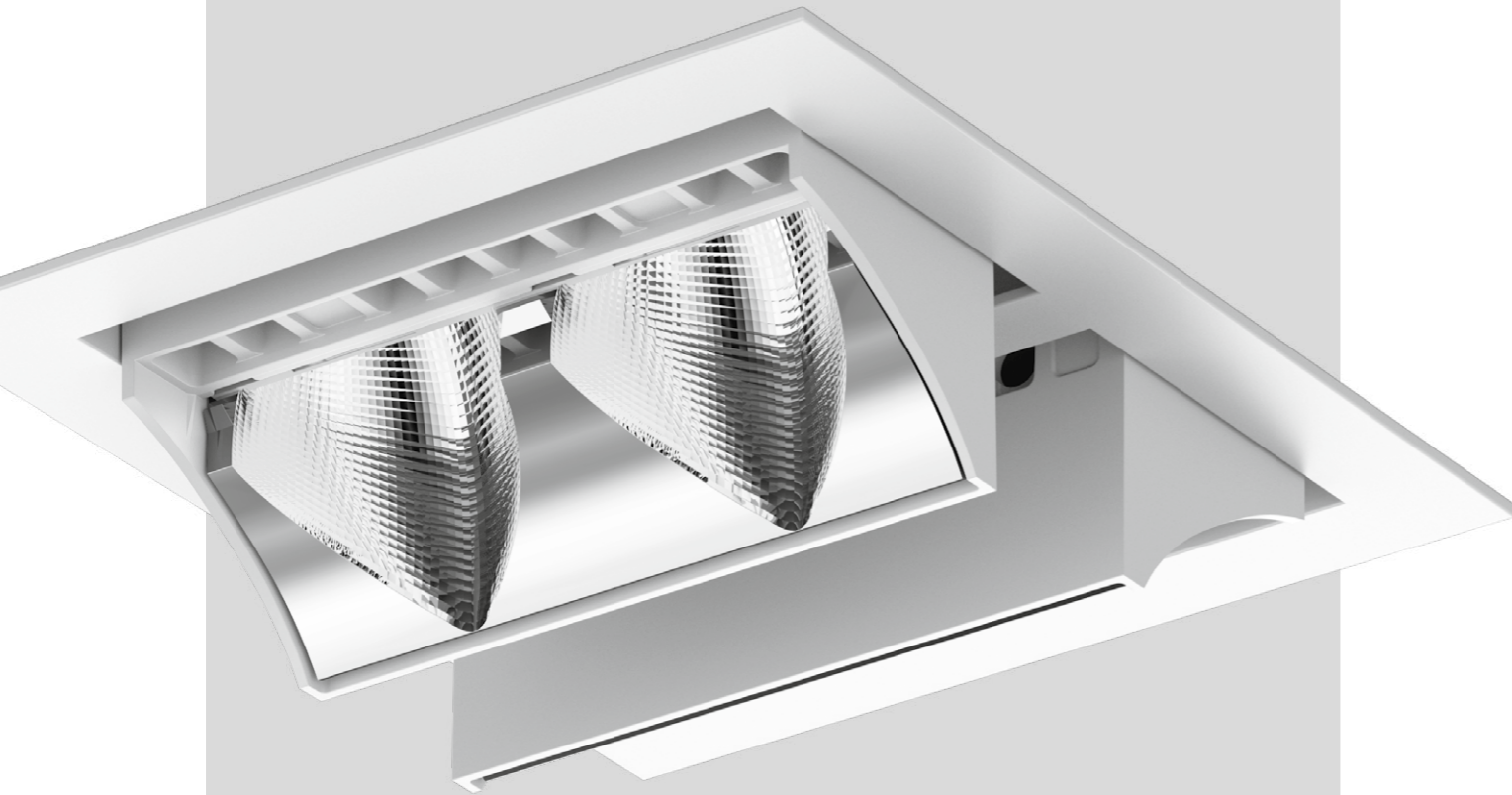

SQUADRO

EN SQUADRO is a track-mounted and recessed spotlight, in a two-lamp single- or double-sided version, for the retail sector that bundles six essential retail requirements in one luminaire. Free-form reflectors with faceted optics make a polished presentation of goods possible. These reflectors direct the light precisely into shelves or aisle zones. Directed light creates a modelling effect on the products and delivers attractive staging. Swivelling light modules illuminate specific shelf levels or billboards while providing plenty of basic lighting. SQUADRO spotlights are completely glare-free, both transversely and longitudinally. They are highly efficient in their energy balance with an efficiency of over 90 %.

IT SQUADRO è un faretto da binario e da incasso, in versione bilampada monolaterale o bilaterale, pensato in particolare per il retail in quanto riunisce in un unico apparecchio i sei principali requisiti che occorrono ai negozi. I prodotti esposti ricavano una presentazione brillante grazie ai riflettori di forma libera con ottiche sfaccettate: questi dirigono la luce in modo preciso ed estremamente mirato verso gli scaffali o le zone delle corsie. La luce diretta modella i prodotti creando una scenografia attraente. I moduli luminosi orientabili illuminano selettivamente i ripiani degli scaffali o i cartelloni pubblicitari, garantendo anche luce di sfondo a sufficienza. I faretti SQUADRO sono completamente schermati in senso longitudinale e trasversale, eppure vantano un'alta efficienza energetica con un rendimento superiore al 90 %.

Types



single-sided 1x2 double-sided 2x2 single-sided 1x2 double-sided 2x2

Mountings

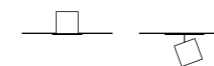

recessed track

Light distributions

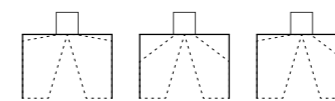

wall floor shelf floor wall/shelf floor

6-in-1 Lighting solution

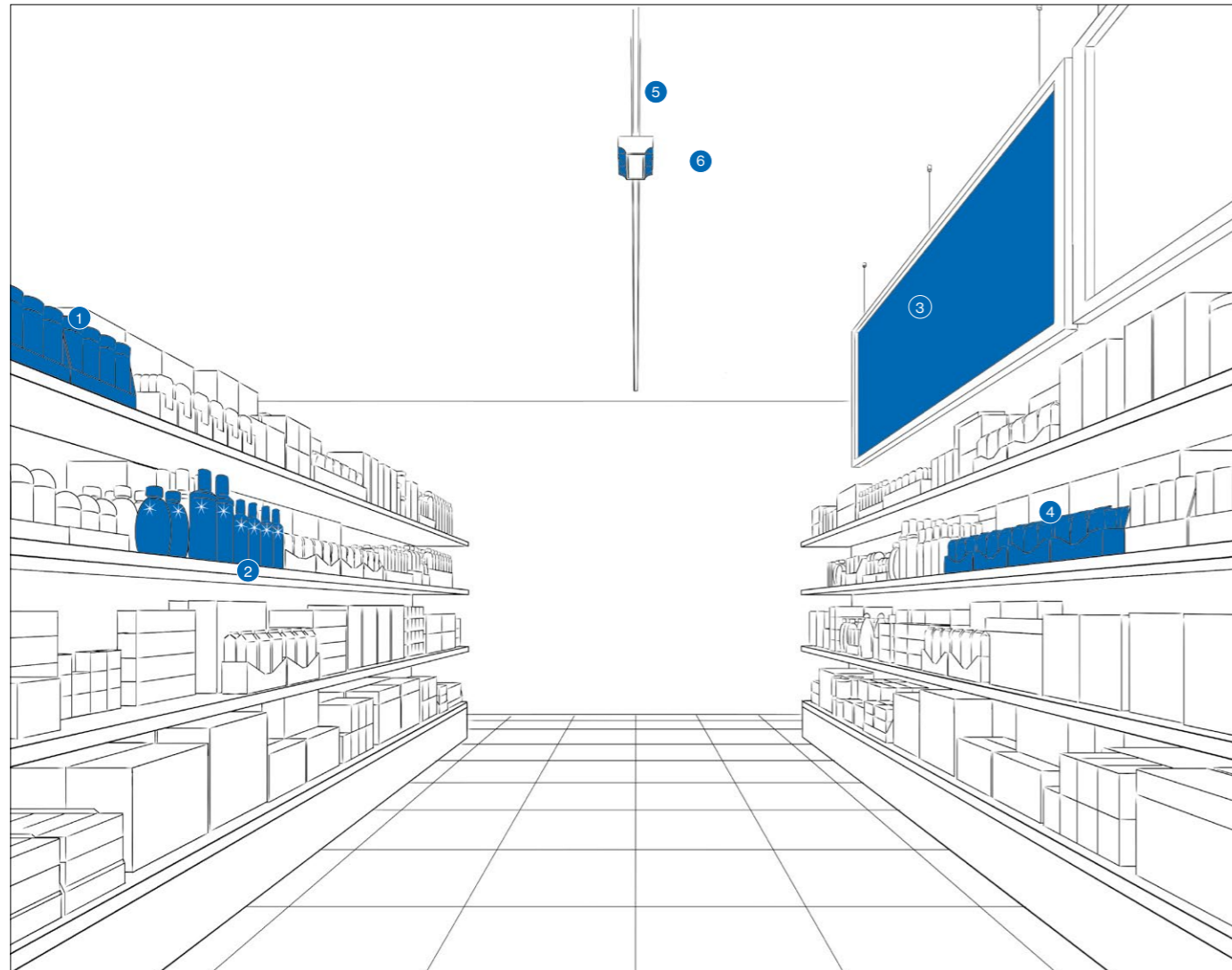

EN SQUADRO combines all the advantages of traditional retail lighting solutions in one luminaire. The spotlights are transversely and longitudinally glare-free and direct the light precisely onto the goods – into the heights and depths of the shelves. This achieves a strong product presentation. Thanks to proper light distribution, no additional light source is required for basic lighting.

IT SQUADRO combina in un corpo illuminante unico tutti i pregi delle soluzioni classiche per il retail. Il prodotto offre un'illuminazione antiabbagliante in senso sia trasversale che longitudinale, proiettando la luce con un fascio preciso sui prodotti esposti e risaltando altezza e profondità degli scaffali. Ne risulta una presentazione di efficacia assoluta. La distribuzione fotometrica è tale da non richiedere corpi illuminanti integrativi per l'illuminazione generale.

- 1 EN The highest illuminance is on the upper two presentation levels.
IT L'illuminamento massimo si concentra sui due piani di presentazione più in alto.
- 2 EN Highlights on premium goods create a brilliant staging.
IT I punti luce presentano i prodotti esposti in maniera scenica e accattivante.
- 3 EN Directed light creates accents on billboards and subjects.
IT La luce direzionata crea accenti su insegne pubblicitarie e punti di attrazione.

- 4 EN The high depth effect gives food high colour contrasts and attractiveness.
IT Il forte effetto in profondità mette in risalto colori e peculiarità dei generi alimentari.
- 5 EN Due to longitudinal glare control, the lighting system is barely perceptible to the customer in the direction of the aisle.
IT Grazie al controllo dell'abbagliamento in senso longitudinale la clientela ha una percezione discreta dell'illuminazione delle corsie.
- 6 EN Transverse glare control additionally prevents glare from any viewing direction.
IT L'aggiunta di una schermatura trasversale esclude l'abbagliamento in ogni direzione dello sguardo.

Five versions

EN SQUADRO's five variants with diverse beam characteristics respond to different shop layouts and requirements. Perfect alignment ensures that minimal luminaires radiate as much light as possible onto the merchandise. SQUADRO adapts to the conditions and illuminates selectively and without scatter loss. All goods are thus attractively presented regardless of the size or interior design of the shop.

IT SQUADRO si adatta ai differenti layout dei negozi con cinque varianti di emissione. Per mettere in luce i prodotti esposti, contenendo il più possibile il numero di corpi illuminanti, ciò che conta è che siano orientati perfettamente. SQUADRO sa adeguarsi alle varie geometrie con un'illuminazione precisa e senza dispersioni. Il risultato è che tutti i prodotti vengono messi in scena con efficacia, a prescindere dalle dimensioni o dall'architettura del negozio.

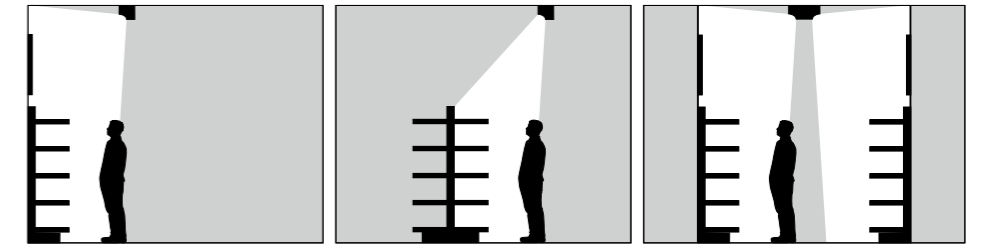

Wall Floor (single-side)

Shelf Floor (single-side)

Wall Floor (double-side)

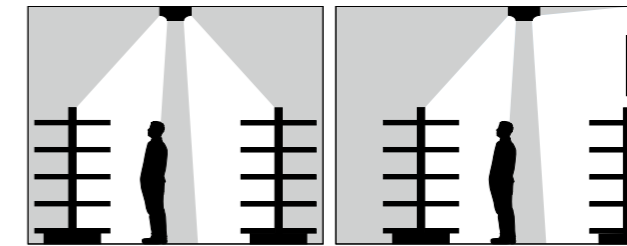

Shelf Floor (double-side)

Shelf / Wall Floor

Unique reflector technology

EN Custom free-form reflectors ensure high-precision light control; each SQUADRO achieves an efficiency of over 90 per cent. The spotlights enjoy optimum glare control through the curved shape and secondary reflector technology.

IT La luce viene guidata con precisione da riflettori speciali graduati ed ogni modello SQUADRO supera il 90 per cento di rendimento. La curvatura e la tecnologia dei riflettori secondari ottimizzano la schermatura.

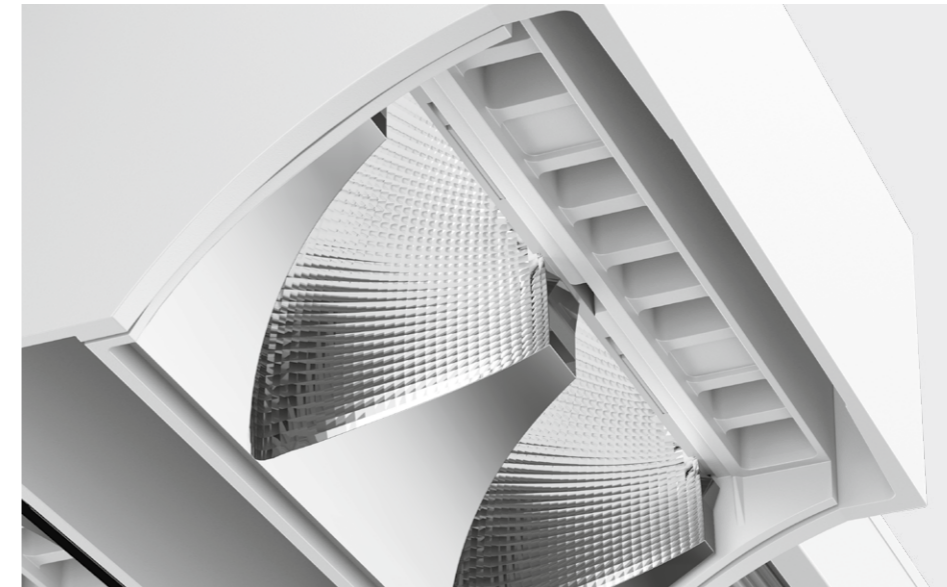

Effective lighting

EN Branches of the same chain often differ in their shop architecture. Shelf heights and aisle widths may vary from one location to another. The solution is step-adjustable light modules. The elements can be tilted from -15° to $+20^\circ$. Each module can be tilted asymmetrically, allowing precise alignment and thus optimum light control.

IT Accade spesso che i negozi di una stessa catena commerciale presentino architetture differenti. Le altezze degli scaffali e le larghezze delle corsie possono variare anche di molto. Soluzione: moduli luminosi orientabili. Sono elementi che si inclinano da -15° a $+20^\circ$. Ogni modulo può essere fissato in posizione asimmetrica, in modo da rimanere orientato con precisione e guidando la luce perfettamente.

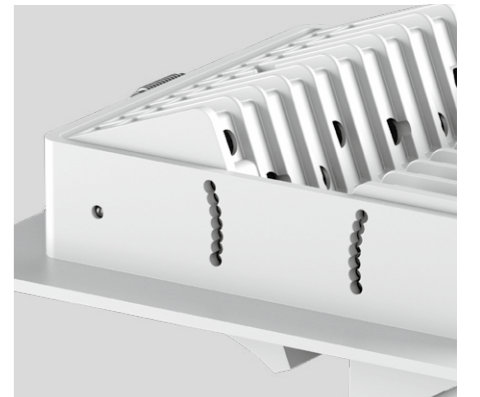

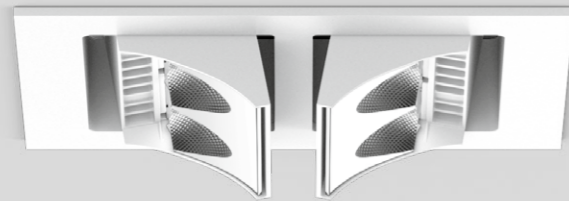
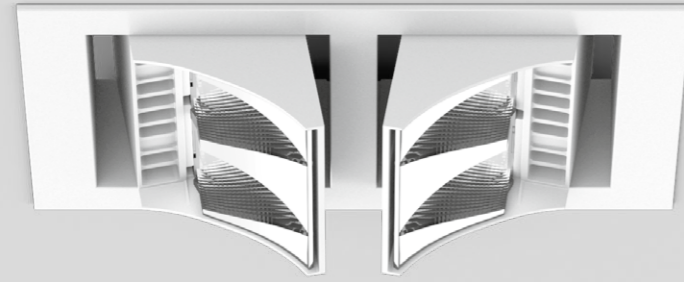

SQUADRO wallwasher

recessed

EN Recessed ceiling spotlight in die cast aluminium in two different types (2 lamps or 2x2 lamps) and with 2 types of light modules (for shelf floor washer and wall floor washer); with trim; surface powder coated; installation without tools using snap spring closure; aisle spotlight with special, multi-free-form, facet effect surface reflectors for high precision light control; precise shelf and aisle zone lighting, optimum longitudinal glare control for high viewing comfort in the aisle zone, adjustable light modules; COB (Chip on Board) technology for maximum efficiency; efficient LEDs with very good colour rendering; IP 40 protection glass available as an accessory

IT Faretto da incasso in soffitto in pressofusione di alluminio in 2 varianti (2 o 2x2 punti luce) e con 2 diversi moduli d'illuminazione (per shelf floor washer e wall floor washer); con bordo perimetrale; verniciatura a polvere; montaggio senza utensili con chiusura a molla a scatto; Faretto per corridoi con riflettori multipli in tecnologia speciale di forma amorfa, con ottica sfaccettata per luce direzionata con la massima precisione; illuminazione di precisione di scaffali e corridoi, ottima schermatura longitudinale per il massimo comfort visivo nei corridoi, moduli luce regolabili; tecnologia COB (Chip on Board) per la massima efficienza; LED efficienti con alta resa cromatica; vetro protettivo IP 40 disponibile come accessorio

Quickinfo

3000K, 4000K
CRI ≥ 90, 3 SDCM
up to 134lm/W
L80 @ 50 000h
non DIM, DALI-2

Types

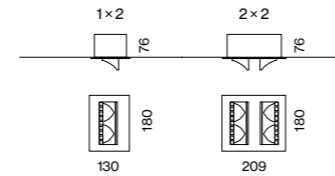

Colours



Light distributions

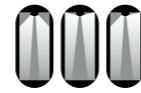

shelf floor
wall floor
shelf wall floor

Order options

COLOUR TEMPERATURE
3000K 0
4000K 1

CONTROL
non DIM 1
DALI-2 3

MATERIAL COLOUR
○ traffic white RAL 9016 7
● jet black RAL 9005 8

REFLECTOR
shelf floor washer S
wall floor washer A
1x shelf / 1x wall floor washer* B

*only for 2x2 lamps

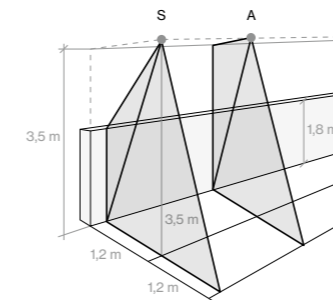

Options on request

COLOUR RENDERING INDEX
CRI ≥ 80

Light distributions

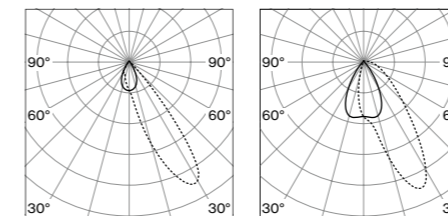

1x2 lamps
shelf floor washer

1x2 lamps
wall floor washer

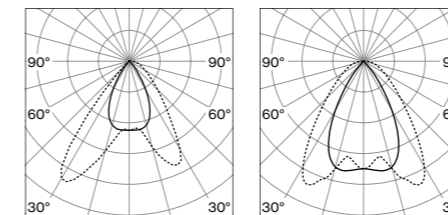

2x2 lamps
1x shelf / 1x wall floor washer

2x2 lamps
wall floor washer

LUMINOUS FLUX value calculated for 4000K
CRI ≥ 90, colour white, wall floor washer
3000K -5%

SQUADRO wallwasher trim



1x2 LAMPS SINGLE-SIDED

SYSTEM POWER 36 W
LUMINOUS FLUX 4720 lm
ORDER CODE 049-2012



2x2 LAMPS DOUBLE-SIDED

SYSTEM POWER 72 W
LUMINOUS FLUX 2x4720 lm
ORDER CODE 049-2020

Optical accessories

IP 40 PROTECTION GLASS

TYPE
1x2 lamps/single-sided 049-2910010
2x2 lamps/double-sided 049-2920010

Technical data

SQUADRO 1x2 lamps, shelf wall washer, trim, 36W, 3000K

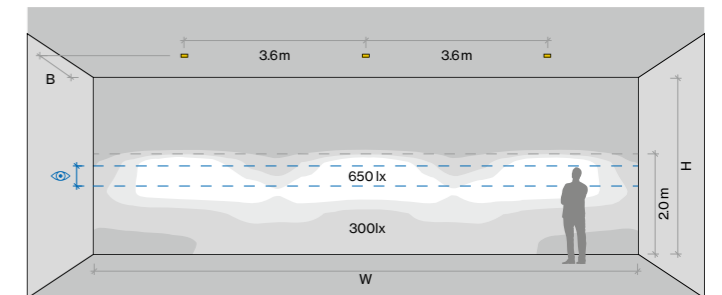

SQUADRO 1x2 lamps, wall floor washer, trim, 36W, 3000K

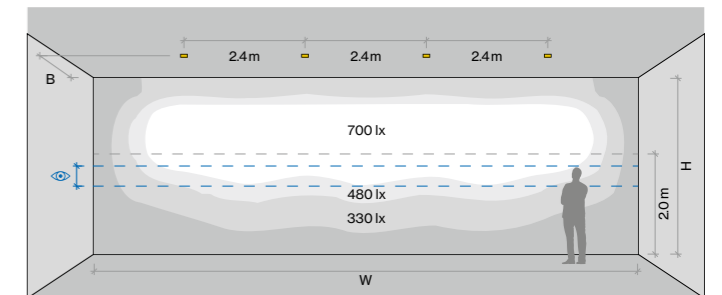

ROOM VALUES
Wall dimensions H = 3.5 m | W = 10.8 m
Distance to wall B = 1.3 m
Aisle width 2.6 m
Reflection factor 0.7 | 0.7 | 0.2
Maintenance factor 0.9

CALCULATION SURFACE
Surface dimensions 10.8 x 3.5 m
Surface height 0 - 3.5 m
Eye level 1.35 m - 1.75 m

Euroshop Dusseldorf, DE –
by blocher partners





SQUADRO wallwasher

track

EN Track light in die cast aluminium in two different types (2 lamps or 2 × 2 lamps) and with 2 types of light modules (for shelf floor washer and wall floor washer); surface powder coated; aisle spotlight with special, multi-free-form, facet effect surface reflectors for high precision light control; precise shelf and aisle zone lighting, optimum longitudinal glare control for high viewing comfort in the aisle zone, adjustable light modules; COB (Chip on Board) technology for maximum efficiency; efficient LEDs with very good colour rendering; IP 40 protection glass available as an accessory; including attachment for linear alignment of the spotlights

IT Faretto da binario elettrificato in pressofusione di alluminio in 2 varianti (2 o 2×2 punti luce) e con 2 diversi moduli d'illuminazione (per shelf floor washer e wall floor washer); verniciatura a polvere; Faretto per corridoi con riflettori multipli in tecnologia speciale di forma amorfa, con ottica sfaccettata per luce direzionata con la massima precisione; illuminazione di precisione di scaffali e corridoi, ottima schermatura longitudinale per il massimo comfort visivo nei corridoi, moduli luce regolabili; tecnologia COB per la massima efficienza; LED efficienti con alta resa cromatica; vetro protettivo IP 40 disponibile come accessorio; incluso accessorio per il posizionamento in linea del corpo illuminante

Quickinfo

3000K, 4000K
CRI ≥ 90, 3 SDCM
up to 134lm/W
L80 @ 50 000h
non DIM, DALI-2

Types

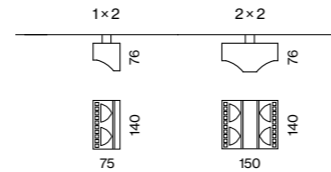

Colours



Light distributions



shelf floor
wall floor
shelf wall floor

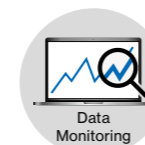

DiiA® standards
251, 252, 253



up to 134lm/W
(high efficiency)



glare-free reflector
longitudinally &
transversely

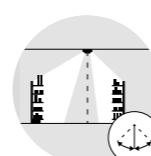

+20° up to -10°
tiltable

Order options

COLOUR TEMPERATURE	
3000K	0
4000K	1

CONTROL	
non DIM	1
DALI-2	3

MATERIAL COLOUR	
○ traffic white RAL 9016	7
● jet black RAL 9005	8

REFLECTOR	
shelf floor washer	S
wall floor washer	A
1 × shelf / 1 × wall floor washer*	B

*only for 2 × 2 lamps

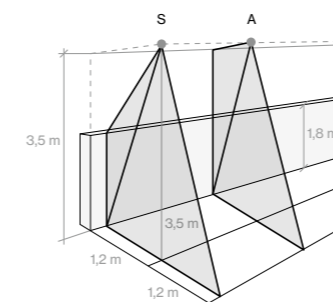

Options on request

COLOUR RENDERING INDEX	
CRI ≥ 80	

CONTROL	
DALI-2 (2 × 2 lamps)	

Light distributions

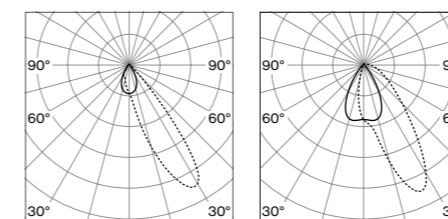

1 × 2 lamps
shelf floor washer

1 × 2 lamps
wall floor washer

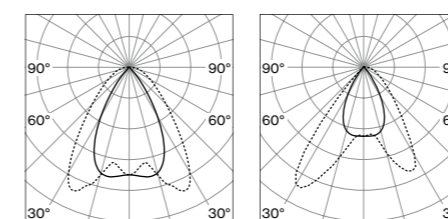

2 × 2 lamps
wall floor washer

2 × 2 lamps
1 × shelf / 1 × wall floor washer

LUMINOUS FLUX value calculated for 4000K
CRI ≥ 90, colour white, wall floor washer
3000K -5%

SQUADRO wallwasher track



1 × 2 LAMPS SINGLE-SIDED

SYSTEM POWER	LUMINOUS FLUX	ORDER CODE
36W	4720lm	149-2210



2 × 2 LAMPS DOUBLE-SIDED

SYSTEM POWER	LUMINOUS FLUX	ORDER CODE
72W	2 × 4720lm	149-2220

Optical accessories

IP 40 PROTECTION GLASS

TYPE	ORDER CODE
1 × 2 lamps/single-sided	049-2910010
2 × 2 lamps/double-sided	049-2920010

Technical data

SQUADRO 1 × 2 lamps, shelf wall washer, trim, 36W, 3000K

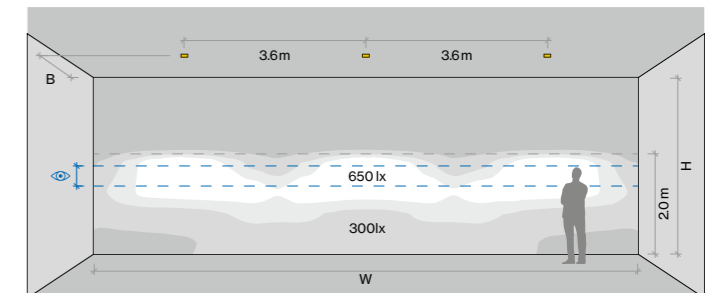

SQUADRO 1 × 2 lamps, wall floor washer, trim, 36W, 3000K

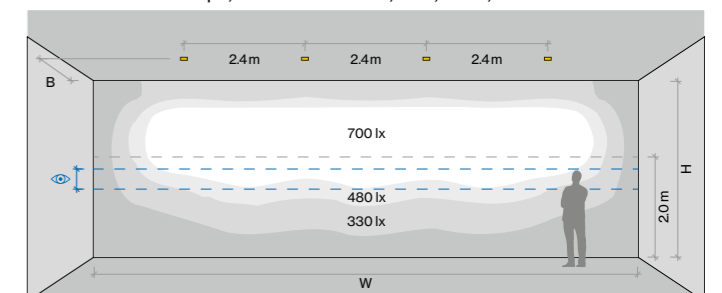

ROOM VALUES		CALCULATION SURFACE	
Wall dimensions	H = 3.5m W = 10.8m	Surface dimensions	10.8 × 3.5m
Distance to wall	B = 1.3m	Surface height	0 - 3.5m
Aisle width	2.6m		
Reflection factor	0.7 0.7 0.2	Eye level	1.35m - 1.75m
Maintenance factor	0.9		

Jelmoli Store
Zurich, CH



Oasis Store Melbourne, AU –
by Sync Design



In the spotlight

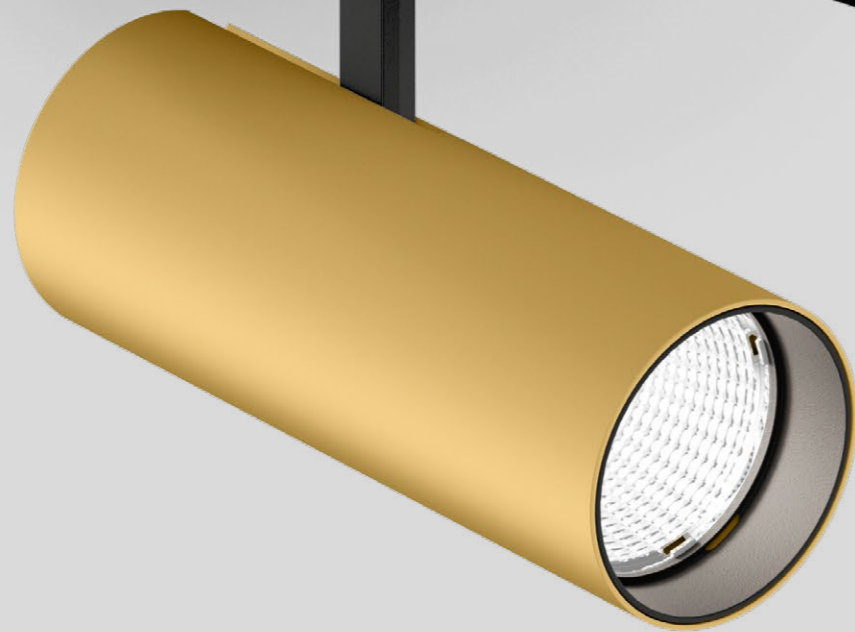

BO intrack

EN Elegant and flexible – this is what characterises the BO track spotlight series. Several sizes and different beam angles offer enormous freedom in setting the scene. The Intrack versions are available as one-, two-, or three-flame spotlights. In addition, the spots can be rotated and pivoted at different angles, making BO an ideal spotlight for shops and staging areas. Different housing and light colours (2700 K, 3000 K, or 4000 K) offer flexibility in different architectural concepts and promise very good colour rendering of up to $\text{CRI} \geq 95$ (2-SDCM).

IT Elegante e flessibile: è questa la prerogativa della serie di faretto da binario BO. Le diverse misure e angoli di emissione lasciano grande libertà compositiva. Le versioni Intrack sono costruite con uno, due o tre punti luce. Inoltre gli spot si ruotano e orientano in diverse angolazioni, rendendo BO la soluzione ideale per negozi e aree espositive. Per un'ulteriore flessibilità architettonica sono previste finiture di vari colori e diverse tonalità di luce (2700 K, 3000 K o 4000 K). La resa cromatica è ottima, fino a $\text{CRI} \geq 95$ (2-SDCM).

Types

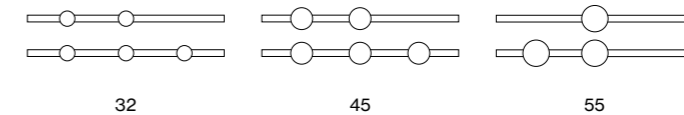

Mounting



track

Light distribution

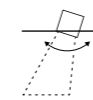

spotlight

Matched proportions

EN Elegance in the right measure: All BO product family spotlights are characterised by their decorative and simple aesthetics. Thanks to their reduced design and precisely coordinated proportions, all BO models can be combined with each other.

IT Eleganza ben dosata: tutti i faretto della linea di prodotti BO vantano un'estetica tanto decorativa quanto semplice. Il design ridotto e le proporzioni calibrate con esattezza permettono di combinare reciprocamente tutti i modelli BO.



Colour variety

EN BO is available in standard white and black. For even more design freedom, additional colour options are available so that you can tailor BO to your individual project. Learn more about our colour palette at xal.com/colours.

IT I faretto BO sono disponibili nei colori bianco e nero come standard. Se occorre adattarli a un progetto individuale potete scegliere anche altre finiture. Per scoprire di più sulla nostra gamma di colori consultate xal.com/colours.



xal.com/colours

Variety

EN The BO Intrack versions are available as single-, double-, or triple-flame spotlights. The spotlight heads are available in three different diameters and different housing and light colours (2700 K, 3000 K, or 4000 K), offering even more flexibility for unique projects. The multi-flame version of the Inset requires only one control gear, which means that the individual spotlights are closer together. This makes these variants not only space-saving but also more cost-efficient.

IT Le versioni BO Intrack sono disponibili con uno, due o tre punti luce. Le testate in tre diametri, finiture di vari colori e diverse tonalità di luce (2700 K, 3000 K o 4000 K) offrono ulteriore flessibilità per un progetto personalizzato. La variante multilampada dell'insetto richiede un solo alimentatore, con il risultato che i singoli faretto rimangono più avvicinati. Di conseguenza questi modelli risultano non solo poco ingombranti ma anche più efficienti in termini di costi.

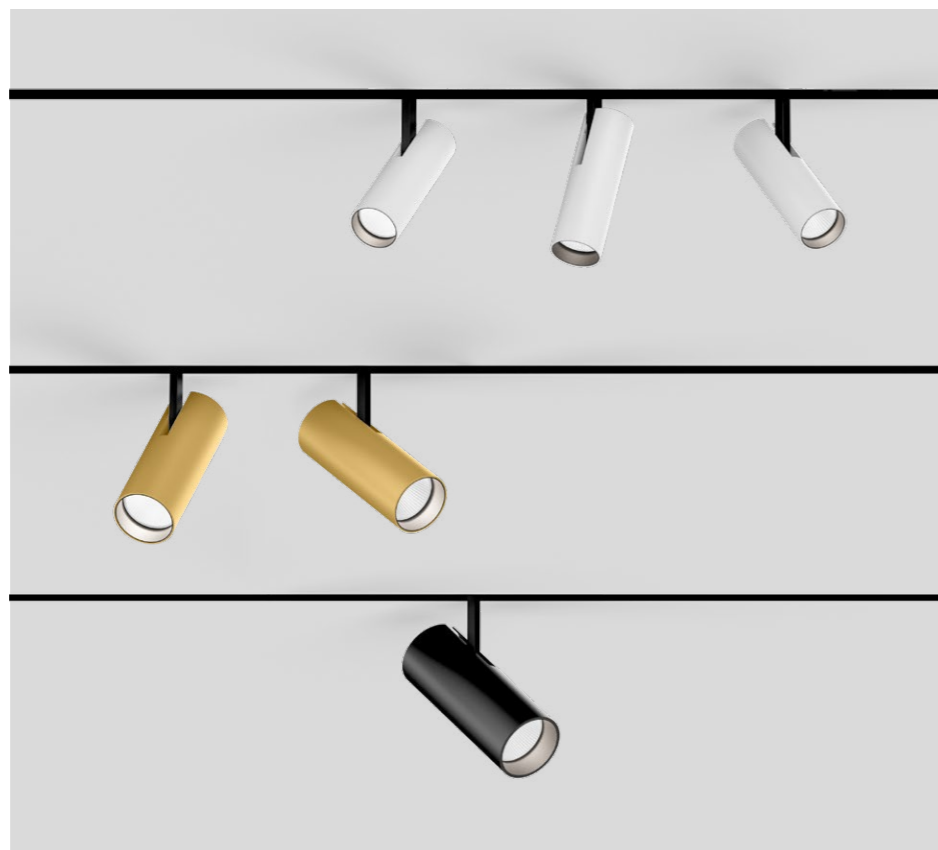

Intrack

EN Flexible adjustment – easy installation: In the track version, BO combines different sizes and beam angles. Thus, ever new lighting scenarios can be implemented: from the selective presentation of goods and products to the staging of art objects and home accessories. The converter disappears elegantly into the track.

IT Regolazione flessibile, montaggio semplice: BO in variante Track unisce misure e angoli di emissione differenti. In questo modo si compongono scenari di luce sempre nuovi: dalle presentazioni puntiformi di prodotti e oggetti alle scenografie di opere d'arte o complementi d'arredo. Il converter sparisce elegantemente nel binario.

Flexible adjustment

EN BO adapts to the requirements to ensure that objects are presented in the best possible light. The spotlight comes in different beam angles and is rotatable by at least 360°, as well as 90° tiltable.

IT BO sa adattarsi al contesto in modo da mettere in scena gli oggetti valorizzandoli al meglio. Il faretto è previsto con diversi angoli di emissione, inoltre si ruota di minimo 360° e si orienta di 90°.

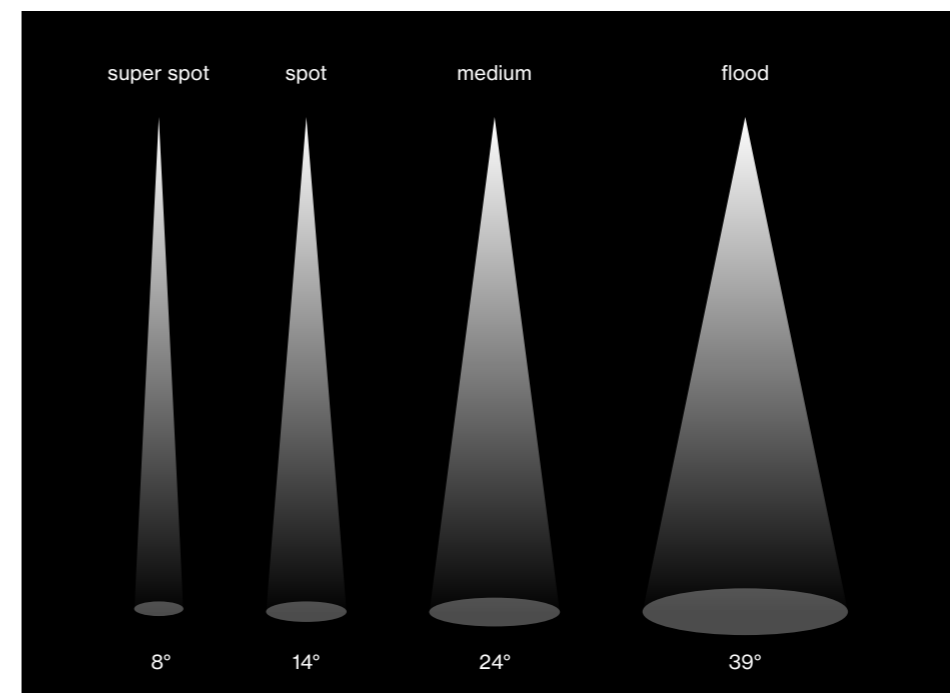

BO 32/45/55

intrack

EN Track light made of die-cast aluminium; powder coated; spotlight head rotates 360° and tilts 90°; choice of single lamp, double lamps or triple lamp; converter in the adapter; with optional high quality lens system with precise radiation characteristic; or high quality, aluminium, vapour deposition coated reflector with faceted design; precise radiation characteristics with different beam angles; good glare reduction due to recessed light point plane; optical attachments as accessories; COB (Chip on Board) technology or high power LEDs - maximum efficiency; no multiple shadows; energy-eff. LEDs - very good colour rendering; adapter for toolless insertion or movement on a variety of 3-phase power tracks; adapter flush with the power track

IT Faretto da binario elettrificato in alluminio pressofuso; verniciatura a polvere; testata ruotabile di 360° e orientabile di 90°; con una, due o tre luci a scelta; convertitore nell'adattatore; a scelta con ottica lenticolare di precisione; oppure riflettore d'alta qualità con ottica sfaccettata in alluminio applicato a vapore; curva fotometrica precisa con diversi angoli di emissione; ottima schermatura con superficie di emissione arretrata; unità ottiche come accessori; tecnologia COB (Chip on Board) o LED high power - massima efficienza; assenza di ombre multiple; LED a risp. energ. - ottima resa cromatica; adattatore per installazione senza utensili o scorrimento in vari binari trifase; adattatore a filo con i binari elettrificati

Quickinfo

2700 K, 3000 K, 4000 K
CRI ≥ 90, 2 SDCM
BO 32 up to 69lm/W
BO 45 up to 91lm/W
BO 55 up to 85lm/W
L80 @ 50 000 h
DALI-2

Types

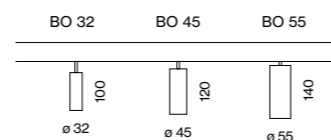

Colours



Light distributions



Order options

COLOUR TEMPERATURE	
2700 K	4
3000 K	5
4000 K	6

CONTROL

DALI-2

MATERIAL COLOUR

○ traffic white RAL 9016	7
● jet black RAL 9005	8
● special colours	X

BEAM ANGLE BO 32

spot 18°	S
medium 23°	M
flood 37°	F

BEAM ANGLE BO 45

super spot 8°	V
spot 14°	S
medium 24°	M
flood 39°	F

BEAM ANGLE BO 55

spot 17°	S
medium 23°	M
flood 37°	F

Options on request

COLOUR RENDERING INDEX

CRI ≥ 95, 2 SDCM

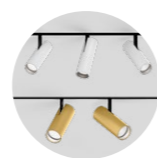

only one adapter
with 2 or 3 lamps



360° rotatable
90° tiltable

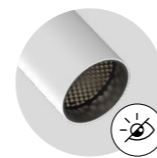

glare control via
honeycomb louver

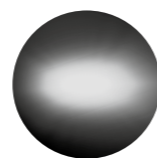

oval lens for oval
light illumination

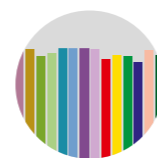

CRI ≥ 95
2 SDCM

LUMINOUS FLUX value calculated for
3000 K, CRI ≥ 90, colour white, flood
2700 K -5%, 4000 K +7%



BO 32 intrack

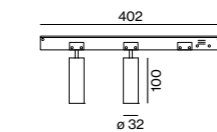

TRACK LIGHT

TYPE	SYS. POWER	LUMINOUS FLUX	ORDER CODE
2 lamps	20.5 W	1440 lm	180-7140::3▲▲
3 lamps	28.8 W	2020 lm	180-7150::3▲▲

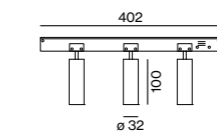

BO 45 intrack

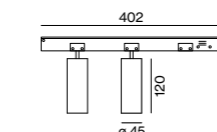

TRACK LIGHT

TYPE	SYS. POWER	LUMINOUS FLUX	ORDER CODE
2 lamps	14.2 W	super spot 2 × 320 lm	180-7240::3▲V
	30 W	spot 2 × 1020 lm	180-7240::3▲S
3 lamps	32 W	med., flood 2 × 1330 lm	180-7240::3▲▲
	45 W	spot 3 × 1020 lm	180-7250::3▲S
	42 W	med., flood 3 × 1180 lm	180-7250::3▲▲

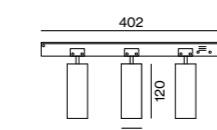

BO 55 intrack

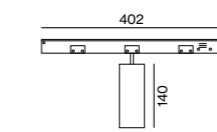

TRACK LIGHT

TYPE	SYS. POWER	LUMINOUS FLUX	ORDER CODE
1 lamp	24.8 W	1940 lm	180-7330::3▲▲
2 lamps	43 W	3460 lm	180-7340::3▲▲

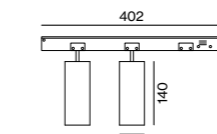

Optical accessories

HONEYCOMB LOUVER

TYPE	Ø H (mm)	ORDER CODE
BO 32	30-3	007-1965168
BO 45	42-3	007-1965188
BO 55	50-3	007-1965598

OVAL LENS

TYPE	Ø H (mm)	ORDER CODE
BO 32	30-3	007-1965860
BO 45	42-3	007-1965880
BO 55	50-3	007-1965890

SOFT LENS

TYPE	Ø H (mm)	ORDER CODE
BO 32	30-3	007-1965960
BO 45	42-3	007-1965980
BO 55	50-3	007-1965990

Euroshop
Dusseldorf, DE –
by blocher partners





Oberpollinger | The KaDeWe Group
Munich, DE – by Licht Kunst Licht AG
including lighting design



Universal expert

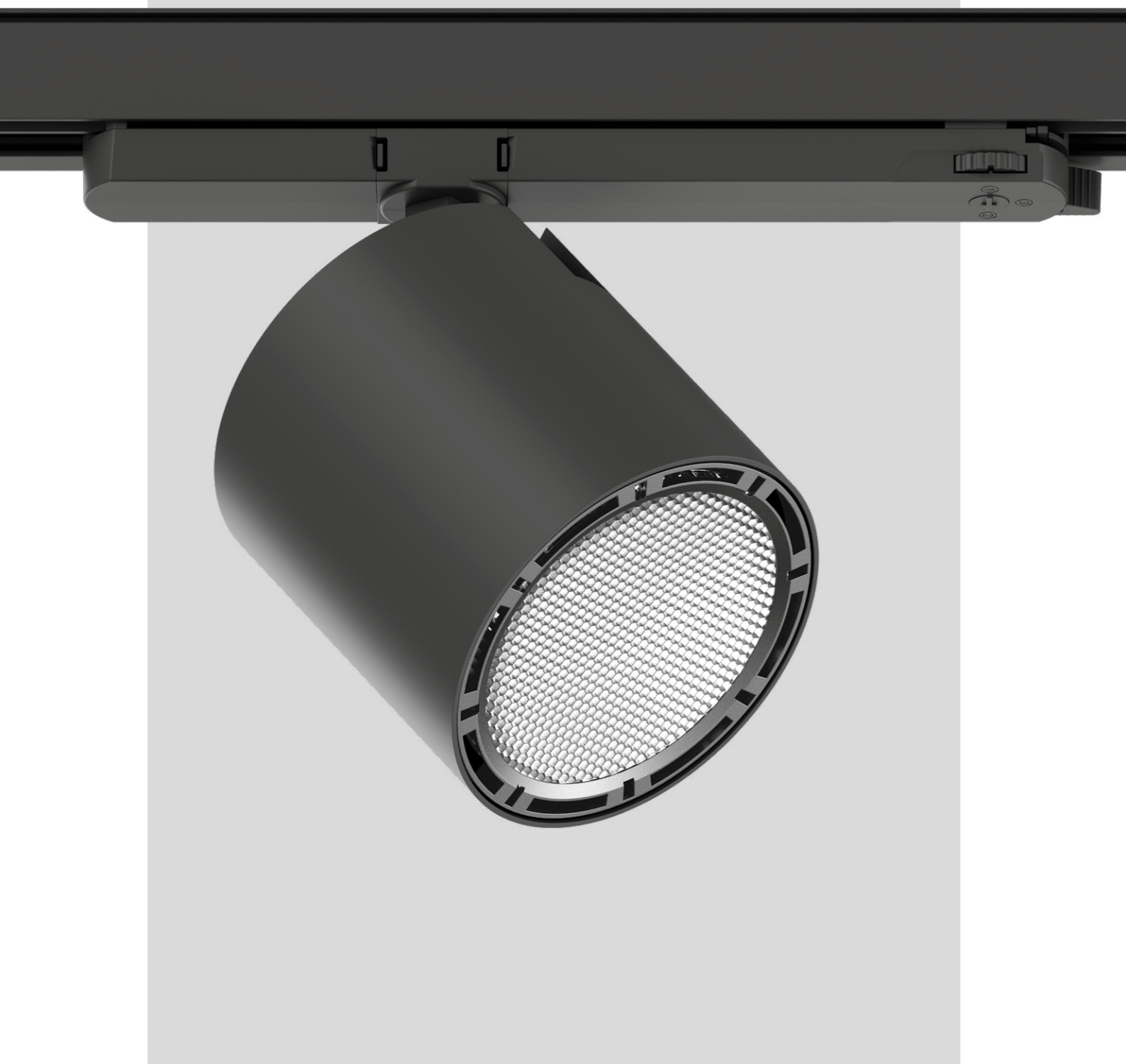

VARO

EN As a track-mounted spotlight, VARO focuses on the essentials and can be used universally. It is available in two different sizes and, thanks to its 355° rotation and 90° swivelling capability, is extremely flexible in use. This flexibility is supported by the fact that the spotlights can be inserted and moved along the track without tools. It is ideal for use in shops whose interior design is continually evolving. In addition, the powerful VARO provides maximum efficiency for the illumination of products. The high-quality reflector from VARO ensures a particularly precise beam characteristic at different angles, all with an excellent colour rendering up to $CRI \geq 90$. Depending on the desired spatial effect, you can choose between the 3000 K and 4000 K light colours.

IT Il faretto per binari elettrificati VARO si concentra sull'essenziale e si utilizza universalmente. È previsto in due misure, si ruota di 355° e si inclina di 90°. Anche il tipo di montaggio assicura grande flessibilità: il faretto si inserisce nel binario elettrificato e si sposta nel modo preferito senza bisogno di utensili. Pertanto si tratta di una soluzione ideale soprattutto nei negozi, dove gli allestimenti cambiano di continuo. Inoltre il faretto vanta la massima efficienza nell'illuminazione di oggetti esposti. VARO possiede un riflettore di qualità che distribuisce la luce con precisione a diverse angolature. Inoltre possiede l'ottimo indice di resa cromatica $CRI \geq 90$. A seconda dell'atmosfera richiesta, potete scegliere la temperatura di colore 3000 K o 4000 K.

Types



80

110

Mounting



track

Light distribution

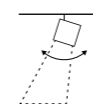

spotlight



VARO 80 S

track

EN Track light made of die-cast aluminium; surface powder coated; spotlight head 355° rotatable and 90° tiltable; integrated converter in the plastic adapter; high quality reflector with spherical facet finish; precise radiation characteristics with different beam angles; installed and exchanged without tools; optical attachments as accessories; optical attachments can be combined; COB (Chip on Board) technology for maximum efficiency; variants with > 120 lm/W available; no multiple shadows; energy-efficient LEDs with very good colour rendering; adapter for toolless insertion or movement on a variety of 3-phase power tracks

IT Faretto da binario elettrificato in alluminio pressofuso; verniciatura a polvere; testata girevole 355° e orient. 90°; converter integrato nell'adattatore in plastica; riflettore di alta qualità con ottica a sfaccettature sferiche; curva fotometrica precisa con diversi angoli di emissione; montaggio e smontaggio senza utensili; unità ottiche come accessori; accessori ottici combinabili tra loro; con tecnologia COB (Chip on Board) per la massima efficienza; disponibili varianti con > 120 lm/W; assenza di ombre multiple; LED ad efficienza energetica con elevata resa cromatica; adattatore per installazione senza utensili o scorrimento in vari binari trifase

Quickinfo

3000K, 4000K
CRI ≥ 90, 3 SDCM
up to 129lm/W
L95/50 000h
non DIM, DALI-2

Type

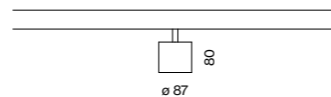

Colours



Light distributions



Order options

COLOUR TEMPERATURE	
3000K	0
4000K	1

CONTROL	
non DIM	1
DALI-2	3

MATERIAL COLOUR	
○ traffic white RAL 9016	7
● jet black RAL 9005	8

BEAM ANGLE	
spot 17°	S
medium 28°	M
flood 38°	F

Options on request

COLOUR RENDERING INDEX
CRI ≥ 80

CONTROL
Casambi
DALI-2 (high efficiency)

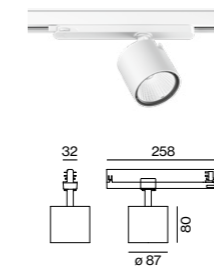

VARO 80 S track



TRACK LIGHT

SYSTEM POWER	LUMINOUS FLUX	ORDER CODE
28.5W	2600lm	180-6420::1▲▲
45W	3610lm	180-6421::1▲▲

HIGH EFFICIENCY

SYSTEM POWER	LUMINOUS FLUX	ORDER CODE
21.3W	2730lm	180-6422::1▲▲
25.4W	3160lm	180-6423::1▲▲

Optical accessories

LENSES AND HONEYCOUMB LOUVER

TYPE	Ø H (mm)	ORDER CODE
linear prismatic lens	75-9	080-6402110P
honeycomb louver	75-9	080-6401118

SNOOT

TYPE	Ø H (mm)	ORDER CODE
short	66-23	080-6403118
medium	66-38	080-6403218
angle	66-38	080-6403318



possibility to combine different optical accessories (max. 2 pieces)



up to 129lm/W
(high efficiency)



355° rotatable
90° tiltable

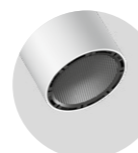

optical
accessories



combine 2 optical
accessories

LUMINOUS FLUX value calculated for
4000K, CRI ≥ 90, colour white, flood
3000K -7%

s.Oliver Store Munich, DE –
by Kitzig Interior Design GmbH
including lighting design





VARO 110 S

track

EN Track light made of die-cast aluminium; surface powder coated; spotlight head 355° rotatable and 90° tiltable; integrated converter in the plastic adapter; high quality reflector with spherical facet finish; precise radiation characteristics with different beam angles; installed and exchanged without tools; optical attachments as accessories; optical attachments can be combined; COB (Chip on Board) technology for maximum efficiency; variants with > 120 lm/W available; no multiple shadows; energy-efficient LEDs with very good colour rendering; adapter for toolless insertion or movement on a variety of 3-phase power tracks

IT Faretto da binario elettrificato in alluminio pressofuso; verniciatura a polvere; testata girevole 355° e orient. 90°; converter integrato nell'adattatore in plastica; riflettore di alta qualità con ottica a sfaccettature sferiche; curva fotometrica precisa con diversi angoli di emissione; montaggio e smontaggio senza utensili; unità ottiche come accessori; accessori ottici combinabili tra loro; con tecnologia COB (Chip on Board) per la massima efficienza; disponibili varianti con > 120 lm/W; assenza di ombre multiple; LED ad efficienza energetica con elevata resa cromatica; adattatore per installazione senza utensili o scorrimento in vari binari trifase

Quickinfo

3000K, 4000K
CRI ≥ 90, 3 SDCM
up to 132lm/W
L95/50 000h
non DIM, DALI-2

Type

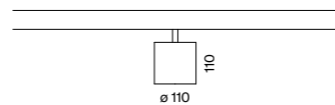

Colours



Light distributions



Order options

COLOUR TEMPERATURE	
3000K	0
4000K	1

CONTROL	
non DIM	1
DALI-2	3

MATERIAL COLOUR	
○ traffic white RAL 9016	7
● jet black RAL 9005	8

BEAM ANGLE	
spot 17°	S
medium 28°	M
flood 38°	F
wide flood 65°	W

Options on request

LUMINOUS FLUX
> 5000lm

CONTROL
Casambi
DALI-2 (high efficiency)

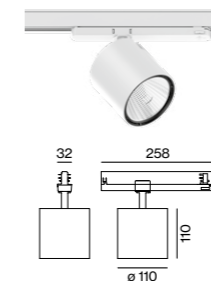

VARO 110 S track



TRACK LIGHT

SYSTEM POWER	LUMINOUS FLUX	ORDER CODE
29.6W	3370lm	180-6520::1▲▲
39W	4300lm	180-6521::1▲▲

HIGH EFFICIENCY

SYSTEM POWER	LUMINOUS FLUX	ORDER CODE
25.7W	3400lm	180-6530::1▲▲
36W	4520lm	180-6531::1▲▲

Optical accessories

LENSES AND HONEYCOUMB LOUVER

TYPE	Ø H (mm)	ORDER CODE
oval lens	106-9	080-6502210
wide flood lens	106-9	080-6502110W
honeycomb louver	106-9	080-6501118

SNOOT

TYPE	Ø H (mm)	ORDER CODE
short	97-23	080-6503118
medium	97-38	080-6503218
angle	97-38	080-6503318



possibility to combine different optical accessories (max. 2 pieces)



up to 132lm/W
(high efficiency)



355° rotatable
90° tiltable

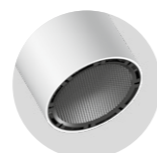

optical
accessories



combine 2 optical
accessories

LUMINOUS FLUX value calculated for
4000K, CRI ≥ 90, colour white, flood
3000K -7%

Kastner & Öhler, Kaufhaus Tyrol
Innsbruck, AT – by DIOMA AG /
WHIR3 / K&Ö Bauabteilung
with lighting design by
VEDDER.LICHTMANAGEMENT



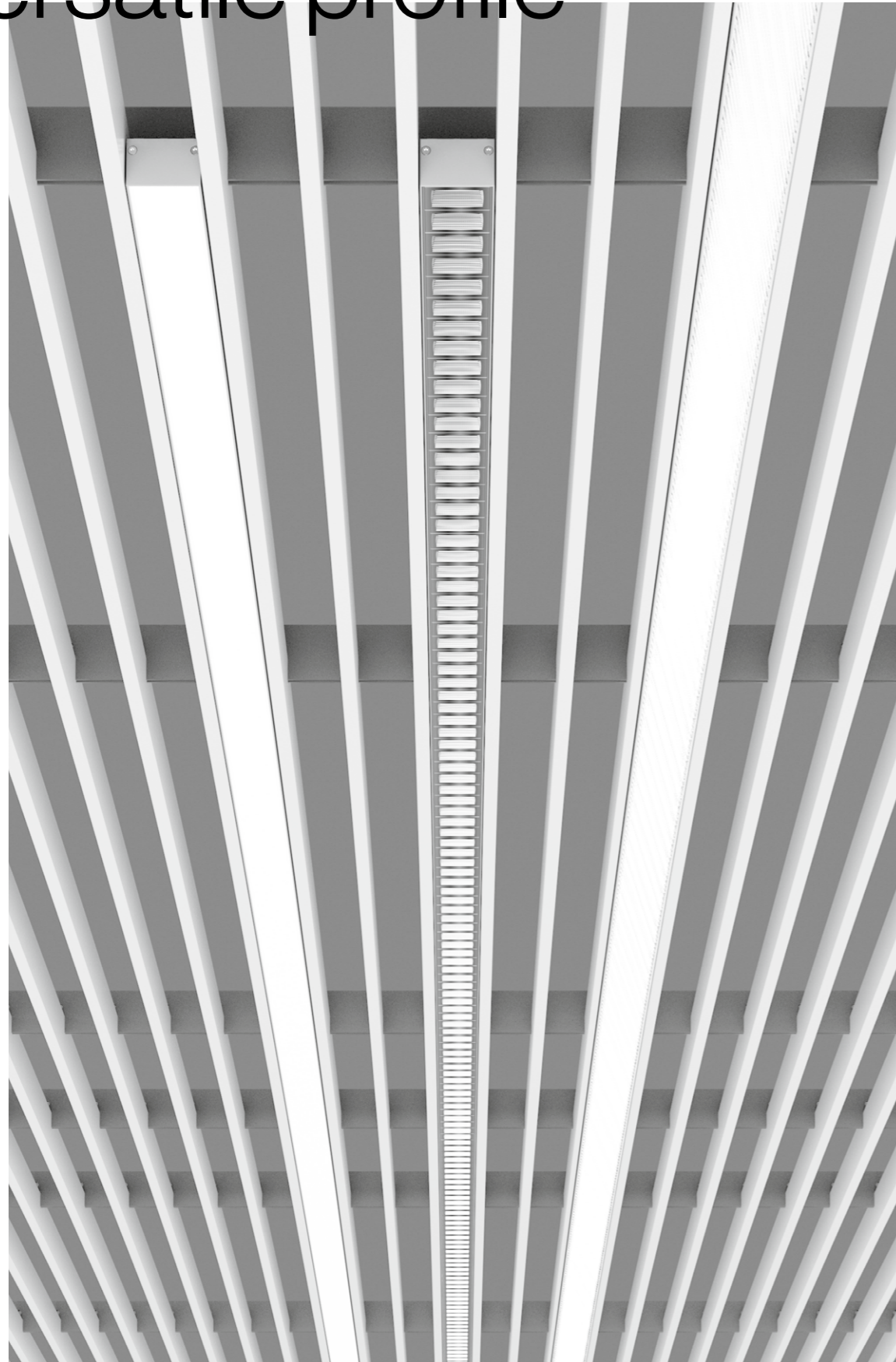

Versatile profile



MILA system

EN The MILA system luminaire was specially designed for use with slat ceilings and blends seamlessly into the respective room concept in entrance halls and office buildings. In meeting rooms and offices, the luminaire creates an ideal, screen-appropriate work light thanks to the optional addition of reflectors. In the opal cover variant, MILA is suitable for homogeneous room illumination; a reduced glare value is achieved with the optional microprismatic cover. For continuous lighting systems, the flexible Continuous Cover is the best choice. By adding special sensors, the MILA system luminaire becomes a smart lighting system. The sensors can be freely placed in the slatted ceiling and quickly integrated at a later stage. The collected room utilisation data helps to save energy over the long term.

IT L'apparecchio in sistema MILA è concepito appositamente per i soffitti a doghe e si integra con armonia in ambienti come sale d'ingresso e uffici. Nelle sale riunioni e negli uffici, quest'apparecchio diffonde una luce ideale per lavorare al computer grazie all'aggiunta opzionale di riflettori. La variante di MILA con rifrattore opale si presta invece a un'illuminazione omogenea dell'ambiente; in alternativa si può scegliere un rifrattore a microprismi che riduce l'abbagliamento. Dove si montano sistemi ininterrotti, la scelta migliore è la flessibile Continuous Cover. Con l'aggiunta di opportuni sensori, l'apparecchio MILA diventa un sistema di illuminazione intelligente. I sensori possono essere collocati liberamente nel controsoffitto a doghe e integrati senza fatica anche in un secondo momento. I dati raccolti sull'utilizzo degli ambienti aiutano a risparmiare energia a lungo termine.

Type	
	38
Mounting	
	ceiling
Configuration	
	linear
Light distributions	
	opal micro-prismatic reflector (UGR ≤ 19) direct



Advanced sensor technology

EN By adding special sensors, the MILA system luminaire becomes a smart lighting system. The sensors can be placed freely and flexibly in the slatted ceiling, and can also be integrated quickly and easily at a later stage. With the ESSENTIAL sensor, the lighting dynamically adapts to the ambient brightness and room activity. In addition, the SENSE sensor measures values for temperature, air quality, humidity, and noise level. These data not only provide important insights into the ambient conditions, but also support energy savings over the long term.

IT Con l'aggiunta di opportuni sensori, l'apparecchio MILA diventa un sistema di illuminazione intelligente. I sensori possono essere collocati liberamente nel controsoffitto a doghe e integrati senza fatica anche in un secondo momento. Il sensore ESSENTIAL consente la regolazione dinamica dell'illuminazione in base alla luminosità circostante e all'attività svolta. La variante SENSE misura anche valori quali temperatura, qualità dell'aria, umidità e livello di rumore. Questi dati non solo forniscono importanti indicazioni sulle condizioni e sull'utilizzo degli ambienti, ma favoriscono anche il risparmio energetico a lungo termine.

Continuous Cover

EN Both the opal and the microprismatic cover are available as continuous versions for the MILA system luminaires. This results in remarkable flexibility, as the length of the cover can be adapted exactly to the system. During installation, the Continuous Cover is simply integrated into the profile, avoiding interfering joints, and creating a pleasantly continuous lighting system.

IT Per gli apparecchi MILA in versione Continuous sono disponibili sia i rifrattori opali che quelli a microprismi. Ne deriva una particolare flessibilità, in quanto la lunghezza della copertura può essere adattata esattamente al sistema. Durante il montaggio basta integrare nel profilo la Continuous Cover, evitando così giunzioni di disturbo e creando un sistema di illuminazione piacevolmente continuo.

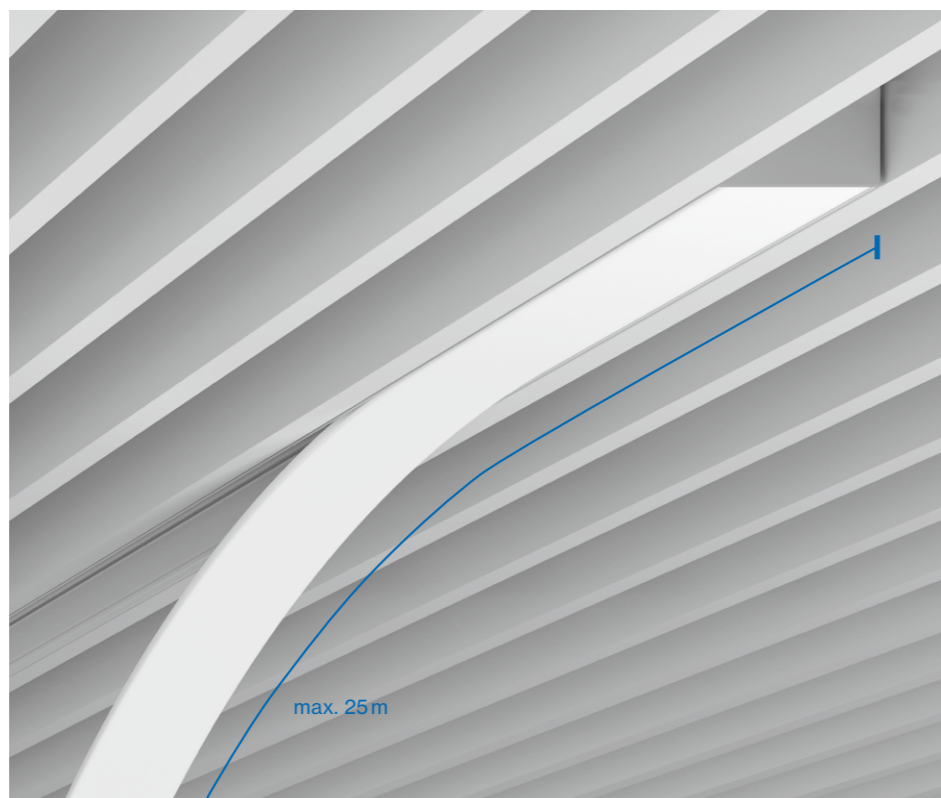

Inset variety

EN Whether workplace lighting or general building areas – the MILA system luminaire can be adapted depending on the area of application. For screen-appropriate task lighting, the $UGR \leq 19$ glare-reduced reflectors are the right choice. The optionally available opal cover is suitable for homogeneous ambient illumination. The microprismatic with reduced glare value are ideal for pleasantly illuminating entrance areas and corridors.

IT Che si tratti di illuminare postazioni di lavoro o aree generiche di edifici, l'apparecchio MILA sa adattarsi alla destinazione. Per il lavoro al computer sono previsti riflettori con schermatura $UGR \leq 19$. Il rifrattore opale in opzione si presta invece a un'illuminazione generale omogenea. La variante a microprismi con abbagliamento ridotto risulta ideale per illuminare piacevolmente aree di ingresso e corridoi.

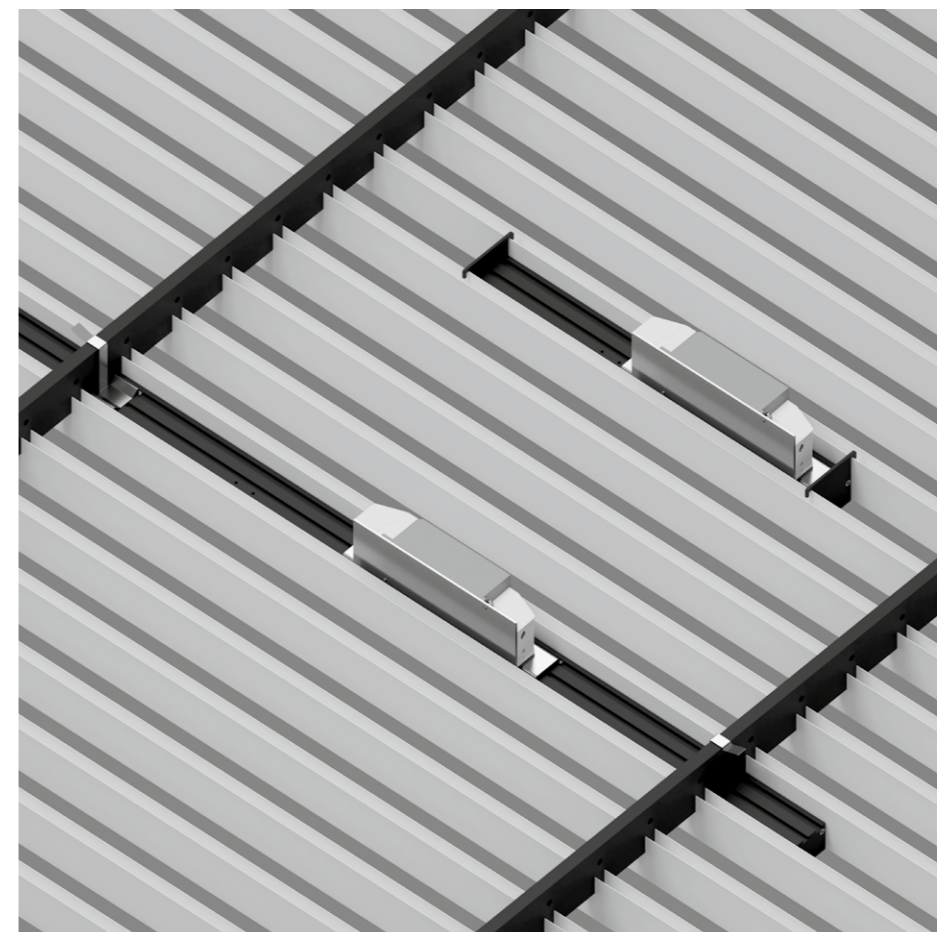

Mounting

EN MILA can provide the right lighting in any room via sturdy mounting brackets that are hooked into the slatted ceiling. The brackets can be flexibly moved along the luminaire and can thus be positioned as required, or subsequently adjusted. Converters with wiring-through function facilitate electrical installation, as wiring can thus be carried out easily and quickly from one luminaire to another. In addition, the free movement of the converter allows a flexible response to ceiling conditions.

IT MILA è in grado di fornire la giusta illuminazione in ogni ambiente grazie a robuste staffe di montaggio che si agganciano al soffitto a doghe. Queste staffe si spostano con flessibilità lungo l'apparecchio e possono quindi essere posizionate secondo necessità oppure regolate successivamente. I converter con funzione wiring-through facilitano l'installazione elettrica in quanto il cablaggio si fa passare con rapidità da un apparecchio all'altro. Inoltre il libero posizionamento del converter consente una risposta flessibile alle condizioni del soffitto.

HAUFE
DECKENSYSTEME

MILA system

ceiling

EN Luminaire housing from extruded aluminium profile, angular design; designed for continuous lighting systems; suitable for installation in the HAUFE louvre ceiling system; surface powder coated; HPO (High Performance Opal) cover or microprismatic cover in the length of the light inset or continuous cover (both separately available); optional high gloss reflector with faceted design; converter flexible positionable on the luminaire profile; converter suitable for through-wiring; energy-efficient LEDs with very good colour rendering; optionally sensor inset (ESSENTIAL or SENSE) available as accessory

IT Corpo illuminante in profilo di alluminio estruso, modello squadrato; per sistemi di file continue; adatto per il montaggio nel sistema a soffitto a lamelle HAUFE; verniciatura a polvere; cover HPO (High Performance Opal) o cover microprismatica della lunghezza dell'insero luminoso oppure cover continua (entrambe da ordinare separatamente); in opzione riflettore ad alta lucentezza con design sfaccettato; convertitore posizionabile in modo flessibile sul profilo dell'apparecchio; convertitore adatto al cablaggio passante; LED ad efficienza energetica con elevata resa cromatica; inserto luminoso con sensore (ESSENTIAL o SENSE) disponibile opzionalmente come accessorio

Quickinfo

3000K, 4000K
CRI ≥ 90, 3 SDCM
UGR ≤ 19 / 65° ≤ 1500 cd/m²
up to 115 lm/W
up to 103 lm/m
L90 @ 50 000 h
DALI-2
opal, microprismatic
reflector (UGR ≤ 19)

Types

opal / microprismatic

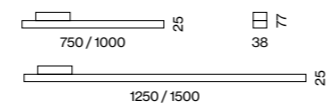

reflector

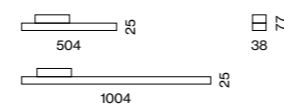

Colours



Light distribution



direct



DiiA® standards
251, 252, 253



suitable for
HAUFE ceilings

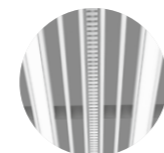

continuous
lighting system



sensor for
single mounting



DIN EN 12464-1
UGR ≤ 19



up to 115 lm/W
(high efficiency)

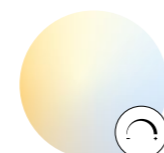

tunable white
2700–6500 K

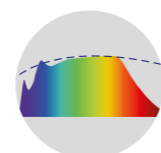

CRI ≥ 98
XPECTRUM

Order options

COLOUR TEMPERATURE	
3000K	0
4000K	1

CONTROL

DALI-2

MATERIAL COLOUR

<input type="radio"/> traffic white RAL 9016	7
<input checked="" type="radio"/> jet black RAL 9005	8

LIGHT OPTIC COVER

opal	H
microprismatic	Z
reflector (UGR ≤ 19)	

Options on request

COLOUR RENDERING INDEX
CRI ≥ 98 XPECTRUM

COLOUR TEMPERATURE

tunable white 2700–6500 K

SLAT CEILING SOLUTION

Hunter Douglas
Interalu SAPPceiling

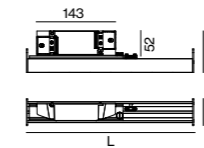

MILA opal/ microprismatic ceiling



SYSTEM LUMINAIRE

SYSTEM POWER	L (mm)	ORDER CODE
15.8W	750	045-9022::3
21W	1000	045-9023::3
25W	1250	045-9024::3
31W	1500	045-9025::3

COVER

TYPE	L (mm)	ORDER CODE
linear	750	006-4107510
linear	1000	006-4110010
linear	1250	006-4112510
linear	1500	006-4115010
continuous linear	6000	006-2106010
continuous linear	25000	006-2125010

LIGHT OPTIC COVER	COLOUR TEMPERATURE	SYSTEM POWER	DELIVERED LUMENS	EFFICACY
opal	3000K	21W/m	2200lm/m	105lm/W
	4000K		2420lm/m	115lm/W
microprismatic	3000K	21W/m	2090lm/m	100lm/W
	4000K		2300lm/m	110lm/W

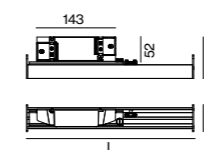

MILA reflector ceiling



SYSTEM LUMINAIRE

SYSTEM POWER	L (mm)	ORDER CODE
11W	504	045-9121::3
22W	1004	045-9123::3

LIGHT OPTIC COVER	COLOUR TEMPERATURE	SYSTEM POWER	DELIVERED LUMENS	EFFICACY
reflector (UGR ≤ 19)	3000K	22 W/m	2790lm/m	126lm/W
	4000K		2950lm/m	133lm/W

Accessories

END CAPS

TYPE	ORDER CODE
end caps (pair)	045-909001

LINEAR CONNECTOR

TYPE	ORDER CODE
mechanical linear connector	045-9091010

SENSOR DALI-2

TYPE	ORDER CODE
ESSENTIAL (brightness & presence)	045-909601
SENSE (brightness, presence, temperature, sound pressure, humidity, CO ₂)	045-909602

Viega GmbH Attersee, AT –
by ATP Planungs- und Beteiligungs AG with
lighting design by Andreas Haidegger

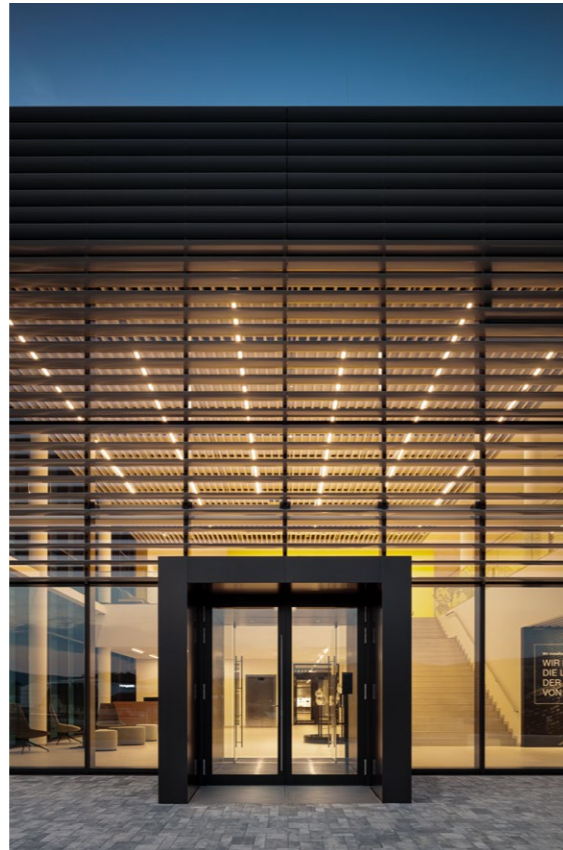











Spotlight your profile



FRAME/MINO 40 system

EN The FRAME 40 and MINO 40 system luminaires set no limits on profile-based ambient lighting. Thanks to special Flex Insets, the system luminaires can be shortened on-site and thus adapted to all conditions. Corner connectors create continuous lighting systems. For particularly uniform room illumination, the profile luminaires are fitted with an opal cover. In addition, spotlight insets can be selected for elegant accent lighting in corridors or entrance areas. Select a light colour of 3000 K, 4000 K, or optionally Tunable White, and a colour rendering of up to $\text{CRI} \geq 98$ (XPECTRUM).

IT Con gli apparecchi in sistema FRAME 40 e MINO 40 non ci sono limiti a un'illuminazione basata su profili. Con gli appositi Flex-Inset, gli apparecchi possono essere accorciati sul posto e quindi adattati a tutti i contesti. I giunti angolari permettono di comporre linee continue ininterrotte. Per assicurare una luminosità particolarmente omogenea, i profili sono coperti da rifrattori opali. Sono previsti anche inserti come spot, da aggiungere per un'elegante illuminazione d'accento in corridoi o aree d'ingresso. Le tonalità di luce disponibili sono 3000 K, 4000 K oppure Tunable White, con una resa cromatica fino a $\text{CRI} \geq 98$ (XPECTRUM).

Type	
	40
Mountings	  
	with trim recessed surface suspended
Configurations	 
	linear corner
Light distributions	   
	opal direct spotlight wallwasher floor

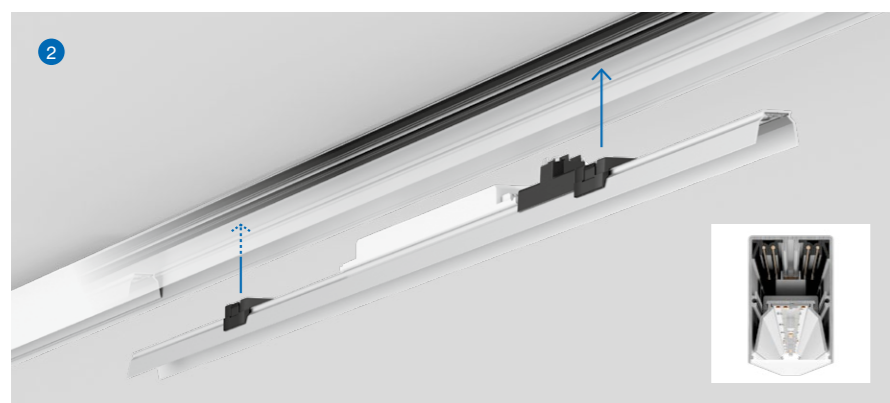
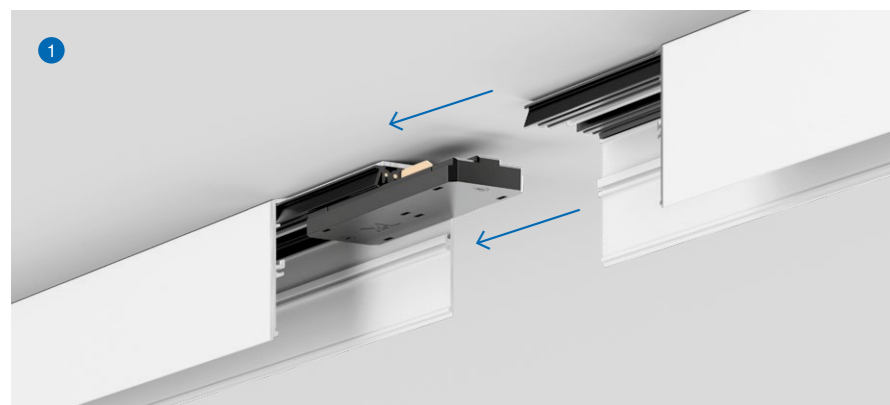

Easy Mounting

EN MINO 40 / FRAME 40 is based on a profile with an integrated track, which makes only one power feed point necessary.

(1) Two profiles are connected to each other with mechanical and electrical connectors.

(2) The patent-pending snap-in system allows the inset to be quickly and easily mounted in the profile. This simplifies the installation and maintenance of the system.

(3) The flexible Continuous Cover can be adjusted exactly to the length of the system and simply installed in the profile during mounting. This creates a continuous lighting system without disturbing joints.

IT MINO 40 / FRAME 40 consistono in un profilo con elettrificazione integrata, quindi occorre un unico punto di alimentazione.

(1) Due profili si collegano reciprocamente con un semplice innesto elettrico e meccanico.

(2) Il sistema Snap-In, in attesa di brevetto, consente di inserire l'inserito nel profilo in modo rapido e semplice. Questo semplifica il montaggio e la manutenzione del sistema.

(3) La flessibile Continuous Cover si adatta esattamente alla lunghezza della linea e si incassa facilmente nel profilo in fase di montaggio. In questo modo si ottiene un sistema di illuminazione continuo senza giunzioni di disturbo.

Full-spectrum LED

EN XAL's new XPECTRUM LEDs deliver healthy, biologically effective light. The reduced blue light component and increased cyan values reduce the blue light hazard for the eye to daylight-equivalent levels. The resulting non-visual, so-called melanopic light effect, improves concentration and increases sleep quality. The excellent colour rendering of IES TM 30-15 $R_f = 98$ and $R_g = 101$ further helps visual comfort.

IT Il nuovo LED XPECTRUM di XAL assicura una luce sana e biologicamente efficace. La ridotta componente di luce blu e l'aumento dei valori del ciano riducono al minimo il pericolo di luce azzurra per gli occhi, portandola a un livello simile a quello della luce diurna. L'effetto luminoso non visivo, detto anche melanopico, favorisce la concentrazione e migliora la qualità del sonno. L'eccellente resa cromatica IES TM 30 - 15 $R_f = 98$ e $R_g = 101$ contribuisce anche a migliorare il comfort visivo.

XPECTRUM LED

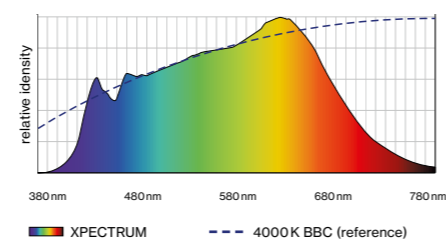

Commercially available LED 4000 K

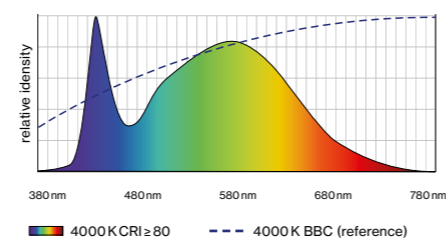

Precise planning with flex insets

EN Your lighting system can be easily adapted to existing room dimensions. You can determine bespoke lengths for MINO 40 / FRAME 40. The special flex insets are precisely and flexibly adapted on-site during assembly. Boards are simply cut off at prefabricated break-points. These are positioned at 62.5 mm or 125 mm, depending on the length of the profile. This gives you a free hand and minimal restrictions in the lighting design.

IT Il sistema di illuminazione si può adattare facilmente alle dimensioni dell'ambiente. Per MINO 40 / FRAME 40 è possibile specificare lunghezze individuali. Gli speciali Flex-Inset si adattano in modo preciso e flessibile durante l'installazione sul posto: i segmenti vengono semplicemente tagliati nei punti di interruzione prefabbricati. Questi si trovano a 62,5 mm o 125 mm, a seconda della lunghezza del profilo. Di conseguenza si ha mano libera e quasi nessuna restrizione nel progetto illuminotecnico.



Spot Insets

EN Elegant room accentuation and reduced design: with the new Spot Insets, the system luminaires become convertible luminaires for stylish wall, floor, and ceiling accentuation. In addition, the Wallwasher Floor light inset is perfect for uniform illumination of a blackboard in the classroom, or a corridor. The tool-free installation of the insets is completed in one move, the spotlights can be simply unlocked and snapped into place.

IT Accenti eleganti nell'ambiente e design essenziale: con i nuovi Spot Inset, gli apparecchi in sistema si sfruttano per accenti luminosi che valorizzano pareti, pavimenti e soffitti. Inoltre l'inserito Wallwasher Floor è perfetto per illuminare in modo uniforme ad esempio la lavagna di un'aula oppure un corridoio. Il montaggio di questi inserti non richiede utensili bensì si esegue con una manopola, mentre i faretto vengono semplicemente sbloccati e inseriti a scatto.

FRAME 40 system

recessed with trim

^{EN} Luminaire housing made of extruded aluminium; recessed luminaire with trim; designed for continuous lighting systems; suitable for ceiling thickness of 8-25 mm; surface powder coated; luminaire profile for mounting available in advance; remaining luminaire components mounted without tools; HPO (High Performance Opal) cover in the length of the light inset or continuous cover (both separately available); pre-assembled power rail for power supply in luminaire profile; voltage tap of the light inset on the power rail; light inset consisting of highly reflective coated extruded profile for improved thermal management; energy-efficient LEDs with very good colour rendering; optionally spotlight modules can be installed

^{IT} Corpo illuminante in profilo di alluminio estruso; apparecchio da incasso con bordo perimetrale; per sistemi di file continue; per soffitti di spessore 8-25 mm; verniciatura a polvere; profilo consegnabile in anticipo; restanti componenti montabili senza utensili; cover HPO (High Performance Opal) della lunghezza dell'insero luminoso o cover continua (entrambe da ordinare separatamente); binario elettrificato premontato per l'alimentazione nel profilo; presa di tens. per inserto lum. sul binario elettr.; unità d'illuminazione in profilo di alluminio estruso con verniciatura altamente riflettente per gestione termica migliorata; LED ad efficienza energetica con elevata resa cromatica; a scelta è possibile installare inserti a faretto

Quickinfo

3000K, 4000K
CRI ≥ 90, 3 SDCM
up to 2420lm/m
up to 123lm/W
L85 @ 50000h
DALI-2

Types

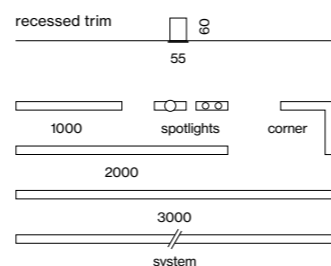

Colours



Light distributions

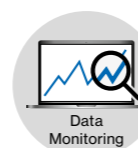

DiiA® standards
251, 252, 253

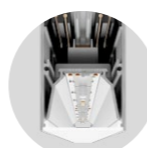

snap-in system
(patent pending)



spotlight
insets (p.130)



breakable
flex insets

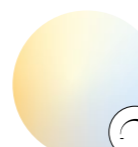

tunable white
2700–6500K

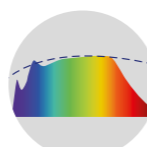

CRI ≥ 98
XPECTRUM

Order options

LED TYPE	
mid lumen	1
high lumen	2

COLOUR TEMPERATURE	
3000K	0
4000K	1

CONTROL	
DALI-2	

MATERIAL COLOUR	
○ traffic white RAL 9016	7
● white aluminium RAL 9006	G
● jet black RAL 9005	8

LENGTH	
1000 mm	1
2000 mm	2
3000 mm	3

LIGHT OPTIC COVER	
opal high performance	

Options on request

COLOUR RENDERING INDEX	
CRI ≥ 98 XPECTRUM	

COLOUR TEMPERATURE	
tunable white 2700–6500K	

LIGHT OPTIC COVER	
microprismatic	

FRAME 40 trim

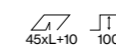

INSTALLATION CHANNEL	L (mm)	ORDER CODE
channel	1000	042-700201
channel	2000	042-700401
channel	3000	042-700601
channel corner 90°/opal cover	500 × 500	042-700C01

LIGHT OPTIC COVER 40	L (mm)	ORDER CODE
linear cover	see left	006-42L0010H
continuous linear cover	6000	006-2206010H
continuous linear cover	30000	006-2230010H
blind cover	see left	006-42L001



LIGHT INSET 40	L (mm)	ORDER CODE
SYSTEM POWER (MID/HIGH LUMEN)		
12.4/20.1W	1000	042-01A237
24.8/40W	2000	042-01A437
37/60W	3000	042-01A637
12.4/20.1W flex	500–1000	042-01AF37
24.8/40W flex	1500–2000	042-01AG37

LED TYPE / COVER	SYSTEM POWER	DELIVERED LM	EFFICACY
mid lumen / opal / 4000K	12.4 W/m	1430 lm/m	116 lm/W
high lumen / opal / 4000K	20.1 W/m	2240 lm/m	112 lm/W

Spotlight Insets

see page 130

Accessories

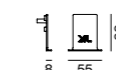

END CAPS	ORDER CODE
TYPE	
end caps (pair)	042-709001

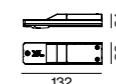

POWER FEEDER UNIT	ORDER CODE
TYPE	
power feeder unit	042-1093230

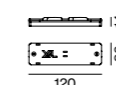

LINEAR CONNECTOR	ORDER CODE
TYPE	
mechanical linear connector	042-7091110
mechanical & electrical linear connector	042-7091230
opal cover linear connector	042-1091910

MOUNTING BRACKET

TYPE	CEILING THICKNESS (mm)	ORDER CODE
mounting bracket (1 piece)	8-25	042-7092110
mounting bracket (25 pieces)	8-25	042-7092110.25

number of brackets required: length of your system in metres+1

LUMINOUS FLUX value calculated for 4000K, CRI ≥ 90, colour white, cover opal 3000K -5%

Psychiatrische Klinik Königshof Krefeld, DE –
by alsh sander.hofrichter architekten GmbH



MINO 40 system

ceiling/suspended

^{EN} Luminaire housing from extruded aluminium profile, angular design; no visible screws; for lighting systems; powder coated; luminaire profile for mounting available in advance; remaining luminaire components mounted without tools; HPO (High Performance Opal) cover in the length of the light inset or continuous cover (both separately available); pre-assembled power rail for power supply in luminaire profile; voltage tap of the light inset on the power rail; ceiling surface mounting or suspended mounting; height adjustment without tools; with transparent feeder cable; light inset consisting of highly reflective coated extruded profile, improved thermal management; energy-eff. LEDs - very good colour rendering; optionally spotlight modules can be installed

^{IT} Corpo illuminante in profilo di alluminio estruso, modello squadrato; nessuna vite visibile; per sistemi di illuminazione; verniciatura a polvere; profilo consegnabile in anticipo; restanti componenti montabili senza utensili; cover HPO (High Performance Opal) della lunghezza dell'insero luminoso o cover continua (entrambe da ordinare separatamente); binario elettrificato premontato per l'alimentazione nel profilo; presa di tens. per inserto lum. sul binario elettr.; montaggio a soffitto o a sospensione; regolazione altezza senza utensili; con cavo di alimentazione trasparente; inserto luminoso costituito da un profilo estruso verniciato altamente riflettente; gestione termica migliorata; LED a risp. energ. - ottima resa cromatica; a scelta è possibile installare inserti a faretto

Quickinfo

3000K, 4000K
CRI ≥ 90, 3 SDCM
up to 2420lm/m
up to 123lm/W
L85 @ 50.000h
DALI-2

Types

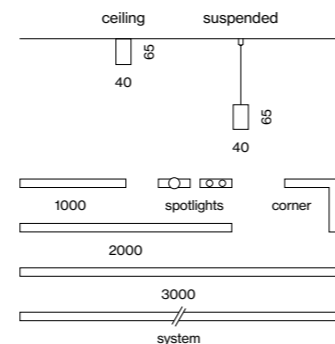

Colours



Light distributions

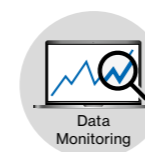

DiiA® standards
251, 252, 253

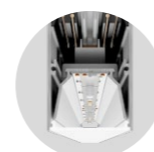

snap-in system
(patent pending)



spotlight
insets (p.130)

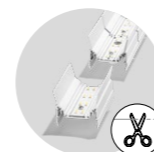

breakable
flex insets

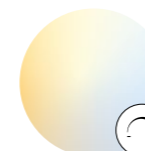

tunable white
2700-6500K

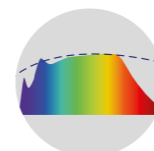

CRI ≥ 98
XPECTRUM

Order options

LED TYPE	
mid lumen	1
high lumen	2

COLOUR TEMPERATURE	
3000K	0
4000K	1

CONTROL	
DALI-2	

MATERIAL COLOUR	
○ pure white RAL 9010	7
● white aluminium RAL 9006	G
● jet black RAL 9005	8
● special colours	X

LENGTH	
1000mm	1
2000mm	2
3000mm	3

LIGHT OPTIC COVER	
opal high performance	

ACCESSORY COLOUR	
○ pure white RAL 9010	7
● jet black RAL 9005	8

Options on request

COLOUR RENDERING INDEX	
CRI ≥ 98 XPECTRUM	

COLOUR TEMPERATURE	
tunable white 2700-6500K	

LIGHT OPTIC COVER	
microprismatic	

MINO 40 ceiling/suspended



INSTALLATION CHANNEL	L (mm)	ORDER CODE
channel	1000	042-100201
channel	2000	042-100401
channel	3000	042-100601
channel corner 90°/opal cover	500 × 500	042-100C01

LIGHT OPTIC COVER 40	L (mm)	ORDER CODE
linear cover	see left	006-42L0010H
continuous linear cover	6000	006-2206010H
continuous linear cover	30000	006-2230010H
blind cover	see left	006-42L001

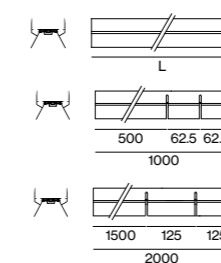

LIGHT INSET 40	L (mm)	ORDER CODE
SYSTEM POWER (MID/HIGH LUMEN)		
12.8/21W	1000	042-01A237
25.6/42W	2000	042-01A437
38/63W	3000	042-01A637
12.8/21W flex	500-1000	042-01AF37
25.6/42W flex	1500-2000	042-01AG37

LED TYPE / COVER	SYSTEM POWER	DELIVERED LM	EFFICACY
mid lumen/opal/4000K	12.8W/m	1560lm/m	122lm/W
high lumen/opal/4000K	21W/m	2420lm/m	115lm/W

Spotlight Insets

see page 130

Accessories

END CAPS	ORDER CODE
TYPE end caps (pair)	042-109001

POWER FEEDER UNIT	ORDER CODE
TYPE power feeder unit	042-1093230

LINEAR CONNECTOR	ORDER CODE
TYPE mechanical linear connector	042-7091110
mechanical & electrical linear connector	042-7091230
opal cover linear connector	042-1091910

CEILING FASTENER / CABLE SUSPENSION / CANOPY	L (mm)	ORDER CODE
TYPE ceiling fastener	10	050-204111
cable suspension	1500	005-2152110
canopy		005-231121
feeder cable (transparent)		005-2412410

for electrical system configuration see luminaire data sheet at xal.com

LUMINOUS FLUX value calculated for 4000K, CRI ≥ 90, colour white, cover opal 3000K -5%



SPOTLIGHT insets

profiles 40

EN Cylindrical spotlight made of aluminium; powder coated; spotlight can be installed without tools in MINO 40 system or FRAME 40 system; choice of single lamp or double lamps; spotlight head rotatable (WALLWASHER / FLOOR) or rotatable and tiltable (SPOTLIGHT); converter in the adapter; with optional high quality lens system with precise radiation characteristic; or high quality, aluminium, vapour deposition coated reflector with faceted design; precise radiation characteristics with different beam angles; optional asym. light distribution; good glare reduction due to recessed light point plane; optical attachments as accessories; COB (Chip on Board) technology or high power LEDs - maximum efficiency; no multiple shadows; energy-eff. LEDs - very good colour rendering

IT Faretto cilindrico in alluminio; verniciatura a polvere; faretto installabile senza attrezzi nel sistema MINO 40 o nel sistema FRAME 40; a scelta a monoemissione o biemissione; testa del faretto ruotabile (WALLWASHER / FLOOR) o ruotabile e orientabile (SPOTLIGHT); convertitore nell'adattatore; a scelta con ottica lenticolare di precisione; oppure riflettore d'alta qualità con ottica sfaccettata in alluminio applicato a vapore; curva fotometrica precisa con diversi angoli di emissione; in opzione distribuzione asim. della luce; ottima schermatura con superficie di emissione arretrata; unità ottiche come accessori; tecnologia COB (Chip on Board) o LED high power - massima efficienza; assenza di ombre multiple; LED a risp. energ. - ottima resa cromatica

Quickinfo

3000K, 4000K
CRI ≥ 90, 2 SDCM
spotlight 32 up to 79lm/W
spotlight 45 up to 85lm/W
L80 @ 50 000h
DALI-2

Types

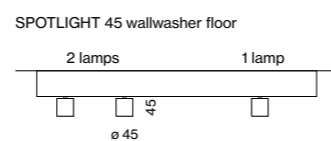
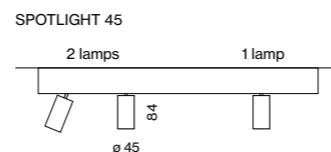
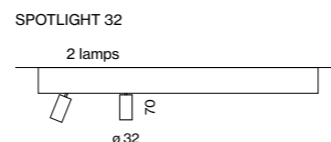

Colours



Light distributions



Order options

COLOUR TEMPERATURE	
3000K	0
4000K	1

CONTROL

DALI-2

MATERIAL COLOUR

<input type="radio"/> traffic white RAL 9016	7
<input checked="" type="radio"/> jet black RAL 9005	8

BEAM ANGLE

SPOTLIGHT 32	
spot 18°	S
medium 23°	M
flood 37°	F

BEAM ANGLE

SPOTLIGHT 45	
spot 14°	S
medium 24°	M
flood 39°	F

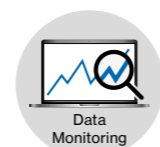

DiiA® standards
251, 252, 253



snap-in system
(patent pending)



wallwasher floor
360° rotatable



wallwasher
floor

LUMINOUS FLUX value calculated for
4000K, CRI ≥ 90, colour white, medium
3000K -5%

SPOTLIGHT 32

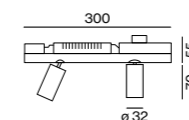

2 LAMPS

SYSTEM POWER	LUMINOUS FLUX	ORDER CODE
20.6W	2 × 810lm	042-0610::3▲
honeycomb louver		007-1965188

SPOTLIGHT 45

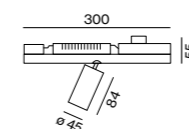

1 LAMP

SYSTEM POWER	LUMINOUS FLUX	ORDER CODE
15W	spot 1060lm	042-0520::3▲S
15.9W	medium, flood 1340lm	042-0520::3▲
honeycomb louver		007-1965188

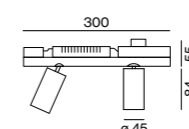

2 LAMPS

SYSTEM POWER	LUMINOUS FLUX	ORDER CODE
30W	spot 2 × 1060lm	042-0620::3▲S
32W	medium, flood 2 × 1340lm	042-0620::3▲
honeycomb louver		007-1965188

SPOTLIGHT 45 wallwasher / floor

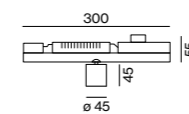

1 LAMP

SYSTEM POWER	LUMINOUS FLUX	ORDER CODE
9W	659lm	042-0520::3▲W

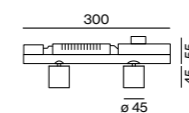

2 LAMPS

SYSTEM POWER	LUMINOUS FLUX	ORDER CODE
15.9W	2 × 659lm	042-0620::3▲W

Corridor
Visualisation



Get in contact

^{EN} We develop and perfect projects in dialogue with the architects and planners to make them unique. We see ourselves as your partner. From lighting design, the right product selection and control system to commissioning and maintenance, we are at your side throughout your project. Let's talk about your project: office@xal.com

^{IT} Ci siamo posti l'obiettivo di sviluppare e perfezionare i progetti, in collaborazione con architetti e progettisti, e di renderli unici. Ci consideriamo il tuo partner. Dalla progettazione alla scelta del prodotto più adatto, fino all'installazione e alla manutenzione, siamo al tuo fianco in tutte le fasi del tuo progetto. Parliamo del tuo progetto: office@xal.com

XAL Headquarters

XAL GmbH
Auer-Welsbach-Gasse 36
8055 Graz
AUSTRIA
T +43.316.3170
office@xal.com

All locations:
xal.com/contacts

List of photographers

Kris Dekeijser (Cover), Kurt Kuball (p. 52-53 | 86-87 | 98-99 | 118-119), Tim Ertl (p. 66-67), Z. Gataric Fotografie (p. 90), Dan Preston (p. 91), Oberpollinger | The KaDeWe Group (p. 95 | 100-101), Jens Pfisterer (p. 110-111), Huy Nguyen (p. 106-107), Markus Bachmann (p. 126-127)

Legal notices

^{EN} Information in this catalogue was valid at the time of printing, is non-binding, and should be used for information purposes only. We are not liable for products that differ from illustrations or information. We reserve the right to make changes to our products at any time. All orders will be accepted exclusively in accordance with our general terms and conditions of business and delivery. The latest version of these terms and conditions is available at www.xal.com.

^{IT} Le informazioni contenute in questo catalogo sono aggiornate al momento della stampa, non sono vincolanti e hanno uno scopo puramente informativo. Non si assume alcuna responsabilità per differenze di un prodotto dalle illustrazioni o dalle descrizioni. Ci riserviamo il diritto di apportare modifiche ai nostri prodotti in qualsiasi momento. Tutti gli ordini sono accettati esclusivamente alle nostre Condizioni Generali di Contratto e Consegna, consultabili su www.xal.com nella versione attualmente in vigore

